



Viabizzuno strada principale della frazione di bizzuno in provincia di ravenna dove tra la casa del popolo e la parrocchia, al n°17, sono nato il ventuno luglio millenovecentocinquantacinque. da qui nasce il nome della fabbrica di produzione fondata nel millenovecentonovantaquattro rappresentata da uno spazio bianco attraversato da due linee. una verticale, rigorosa, essenziale, equilibrata: la luce per la luce; ed una inclinata, irriverente nello spazio, ironica, fuori dagli schemi: la luce per la forma. distinte ma complementari si fondono in un unico nome: Viabizzuno.

marionanni

Viabizzuno is the name of the main road of the small village bizzuno located in the province of ravenna, where I was born on the twenty-first july nineteenfiftyfive at n°17, between the 'casa del popolo' and the local parish church. from here the name of the factory founded in nineteen ninety-four represented by a white space intersected by two lines. one vertical, well balanced, logical, essential: the light for the light. the other one dynamic, irreverent, ironic: the light for the form. separate and yet complementary they cast in the same name: Viabizzuno.

prodotto
product



schede tecniche
data sheets



curve fotometriche
photometric curves



modelli 3d per i tuoi render
3d models for your render



catenaria di luce serpentine

peter zumthor 2011



sistema di illuminazione a sospensione per esterni IP54. realizzato con apparecchi di illuminazione orientabili e fissi in alluminio ossidato e verniciato a polvere. eventuali irregolarità del vetro sono garanzia di un prodotto unico, soffiato e realizzato interamente a mano da maestri vetrai. cavo di sospensione di sezione 13x4mm con conduttori 2x1,5mm² lunghezza 20000mm. cablati con sorgente elettronica 3000K Ra98 5,6W 586lm. ottiche: 36° o diffusa. alimentatore 220-240V 50-60Hz 24Vdc incluso, da installare remotamente. accessori: morsetto/tirante per sospensione, derivazione per alimentazione 24Vdc e 350mA con connettore IP67. finiture: nero notte. personalizza la tua luce vai su www.Viabizzuno.com

IP54 rated suspension light fitting for outdoor use. made of oxidised and powder coated aluminium adjustable and fixed light fittings. any irregularities in the glass are a guarantee of a unique product, blown and entirely hand crafted by master glassmakers. 13x4mm section suspension cable with 2x1,5 mm² conductors of 20000mm length. wired with 3000K Ra98 5.6W 586lm led source. optics: 36° or diffused. 220-240V 50-60Hz 24Vdc power supply included, to be installed remotely. accessories: clip/suspension tie-rod night black, 24Vdc and 350mA derivation unit with IP67 connector. finishes: night black. customize your light visit www.Viabizzuno.com

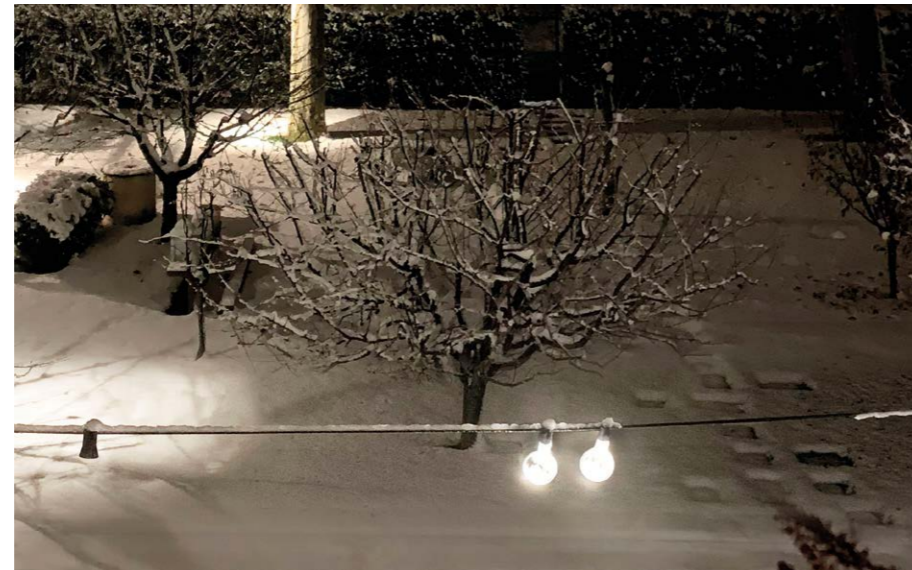

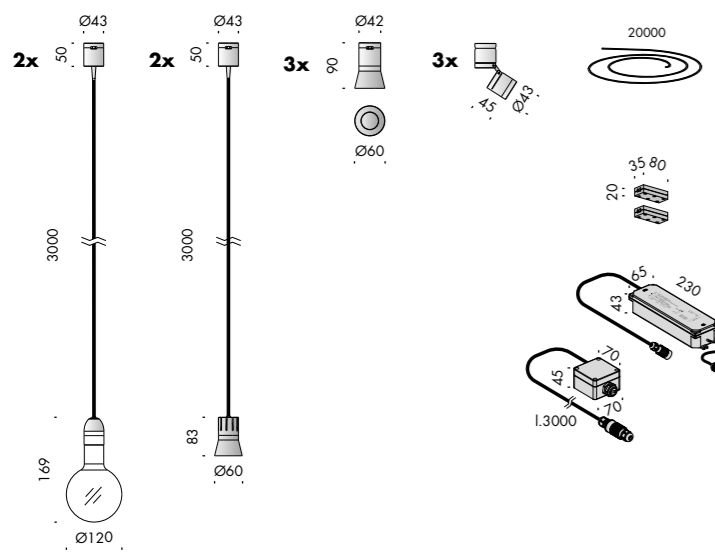

- Via.539.0001** nero notte · night black 8,2
- kit completo di · complete kit with:
- sospensione con vetro trasparente 2 pz · pcs 2x5,6W 3000K
suspension with transparent glass
 - spot cono sospensione 2 pz · pcs 2x5,6W 3000K
suspension cone spot
 - spot cono fisso 3 pz · pcs 3x5,6W 3000K
fixed cone spot
 - spot orientabile 3 pz · pcs 3x5,6W 3000K
adjustable spot
 - cavo bipolare · bipolar cable 1 pz · pcs 20000mm
 - kit morsetti · clips kit 1 pz · pcs
 - alimentatore · power supply 1 pz · pcs

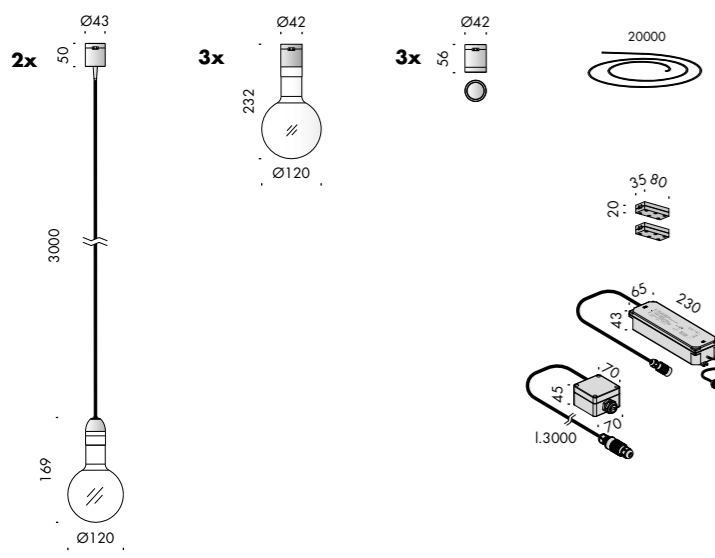

- Via.539.0002** nero notte · night black 7,4
- kit completo di · complete kit with:
- sospensione con vetro trasparente 2 pz · pcs 2x5,6W 3000K
suspension with transparent glass
 - fisso con vetro trasparente 3 pz · pcs 3x5,6W 3000K
fixed with transparent glass
 - spot fisso 3 pz · pcs 3x5,6W 3000K
fixed spot
 - cavo bipolare · bipolar cable 1 pz · pcs 20000mm
 - kit morsetti · clips kit 1 pz · pcs
 - alimentatore · power supply 1 pz · pcs

Ra	R9	ies tm-30	sdc	mA	V _f (min)	lm	W	lm/W
98	95	Rf 95 Rg 100	step 2	350	16,0	586	5,6	105
cd041	les6	Ta25 °C	vita media · average life	50000 h	L70	B10		



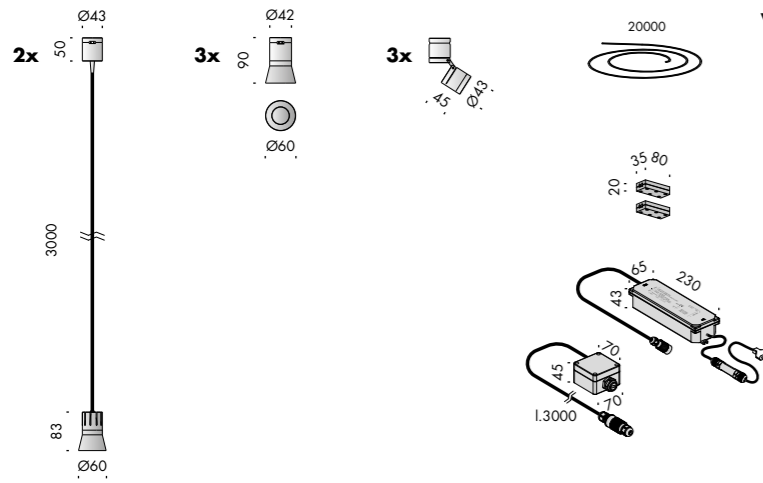

- Via.539.0003** nero notte · night black 7,4
- kit completo di · complete kit with:
- spot cono sospensione suspension cone spot 2 pz · pcs 2x5,6W 3000K
 - spot cono fisso fixed cone spot 3 pz · pcs 3x5,6W 3000K
 - spot orientabile adjustable spot 3 pz · pcs 3x5,6W 3000K
 - cavo bipolare · bipolar cable 1 pz · pcs 20000mm
 - kit morsetti · clips kit 1 pz · pcs
 - alimentatore · power supply 1 pz · pcs

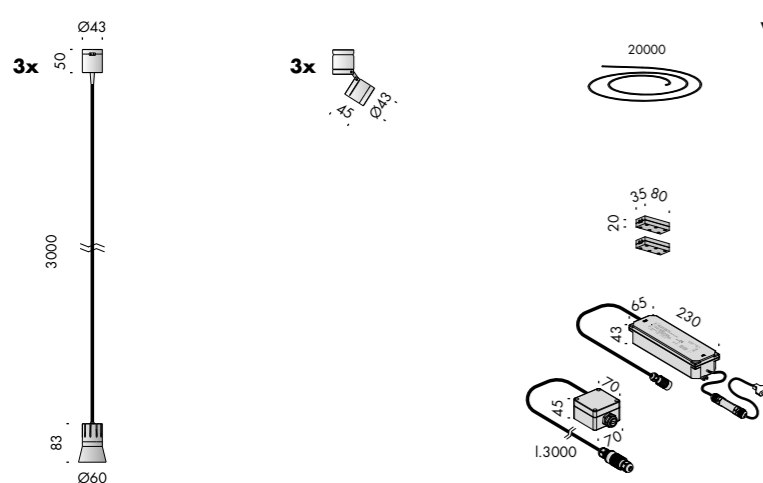

- Via.539.0004** nero notte · night black 7,2
- kit completo di · complete kit with:
- spot cono sospensione suspension cone spot 3 pz · pcs 3x5,6W 3000K
 - spot orientabile adjustable spot 3 pz · pcs 3x5,6W 3000K
 - cavo bipolare · bipolar cable 1 pz · pcs 20000mm
 - kit morsetti · clips kit 1 pz · pcs
 - alimentatore · power supply 1 pz · pcs

Ra	R9	ies tm-30		sdc	mA	V _{f (min)}	lm	W	lm/W
98	95	Rf 95	Rg 100	step 2	350	16,0	586	5,6	105
cd041	les6	Ta25 °C		vita media · average life		50000 h	L70	B10	



*personalizza la tua luce
vai su Viabizzuno.com*



+



+

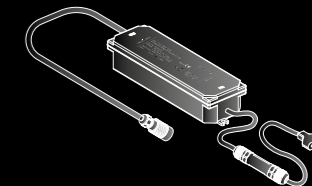

customize your light visit Viabizzuno.com

1. scegli i kit sorgente elettronica
choose the led source kits

2. scegli il cavo
choose the cable

3. scegli l'alimentatore
choose the power supply

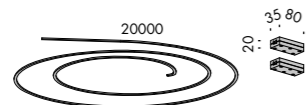

catenaria di luce serpentine 24Vdc IP54 ★ CE i

a8.576.03 blu notte · night blue 20000mm 2x1,5mm² 3,2

componenti. components. IP67 CE i

a9.576.92 box connessione cavo piatto · connection box flat cable 0,9

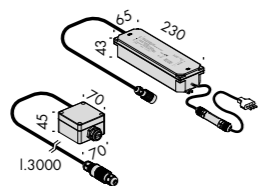
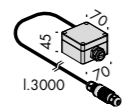

alimentatori. power supplies. 240V/24Vdc IP67 CE i

a9.576.91 alimentatore con box connessione cavo piatto e spina eu 100W 1,8
power supply unit with connection box, flat cable and eu plug

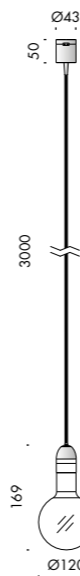
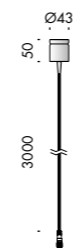
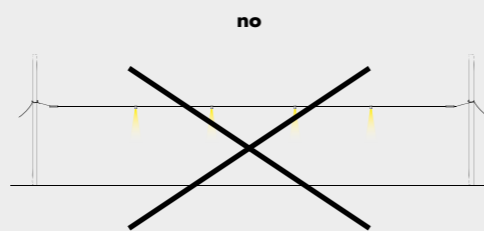
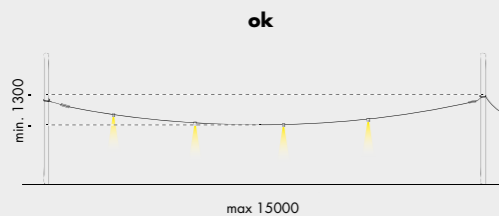

accessori. accessories. ★ CE i

a9.576.81 morsetto/tirante per sospensione nero notte 2 pz · pcs 0,3
clip/suspension tie-rod night black

Vb9.576.85 derivazione per alimentazione con connettore IP67 24Vdc nero notte 0,3
derivation unit with IP67 connector night black

Vb9.576.88 derivazione per alimentazione con connettore IP67 350mA nero notte 0,3
derivation unit with IP67 connector night black

kit Ø120 24Vdc IP54 ★ CE i

Vb6.576.20 fisso con vetro trasparente nero notte 3000K 0,3
fixed with transparent glass night black

Vb6.576.35 sospensione con vetro trasparente nero notte 3000K 0,4
suspension with transparent glass night black

Ra	R9	ies tm-30	sdcM	mA	V _{f (min)}	lm	W	lm/W
98	95	Rf 95 Rg 100	step 2	350	16,0	586	5,6	105
cd041	les6	Ta25 °C	vita media · average life	50000 h		L70	B10	

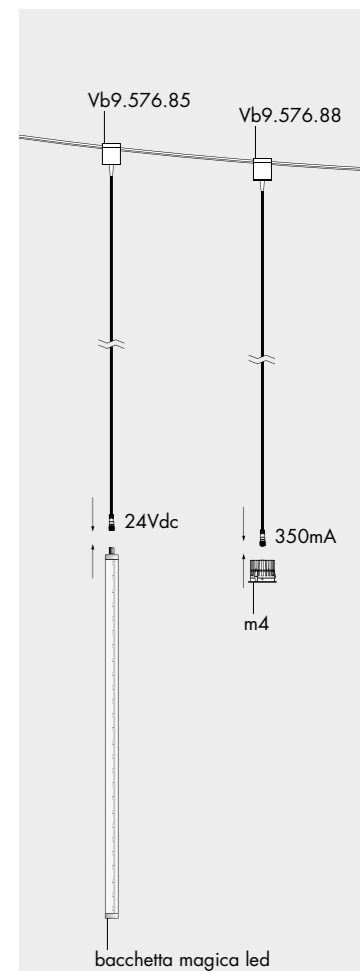

è possibile utilizzare le derivazioni per alimentazione per collegare altri apparecchi di illuminazione. Vb9.576.85 con uscita 24Vdc per bacchetta magica led Vb9.576.88 con uscita 350mA per zero, lucciola e m4. it is possible to use the derivation unit to connect other light fitting. Vb9.576.85 with 24Vdc output for bacchetta magica led. Vb9.576.88 with 350mA output for zero, lucciola and m4.

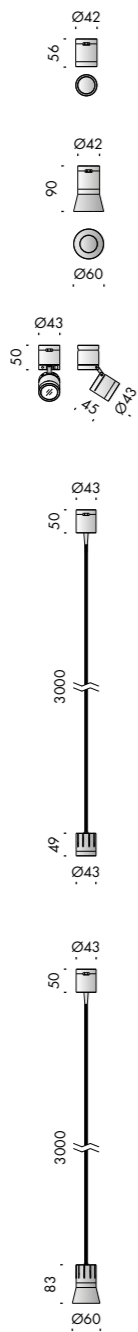

kit spot 36° 24Vdc

Vb6.576.11 fisso
fixed nero notte
night black 3000K 0,2

Vb6.576.14 cono fisso
fixed cone nero notte
night black 3000K 0,2

Vb6.576.23 orientabile
adjustable nero notte
night black 3000K 0,3

Vb6.576.26 sospensione
suspension nero notte
night black 3000K 0,3

Vb6.576.29 cono sospensione
suspension cone nero notte
night black 3000K 0,4

Ra	R9	ies tm-30		sdc	mA	V _{f (min)}	lm	W	lm/W
98	95	Rf 95	Rg 100	step 2	350	16,0	586	5,6	105
cd041	les6	Ta25 °C		vita media · average life		50000 h		L70 B10	



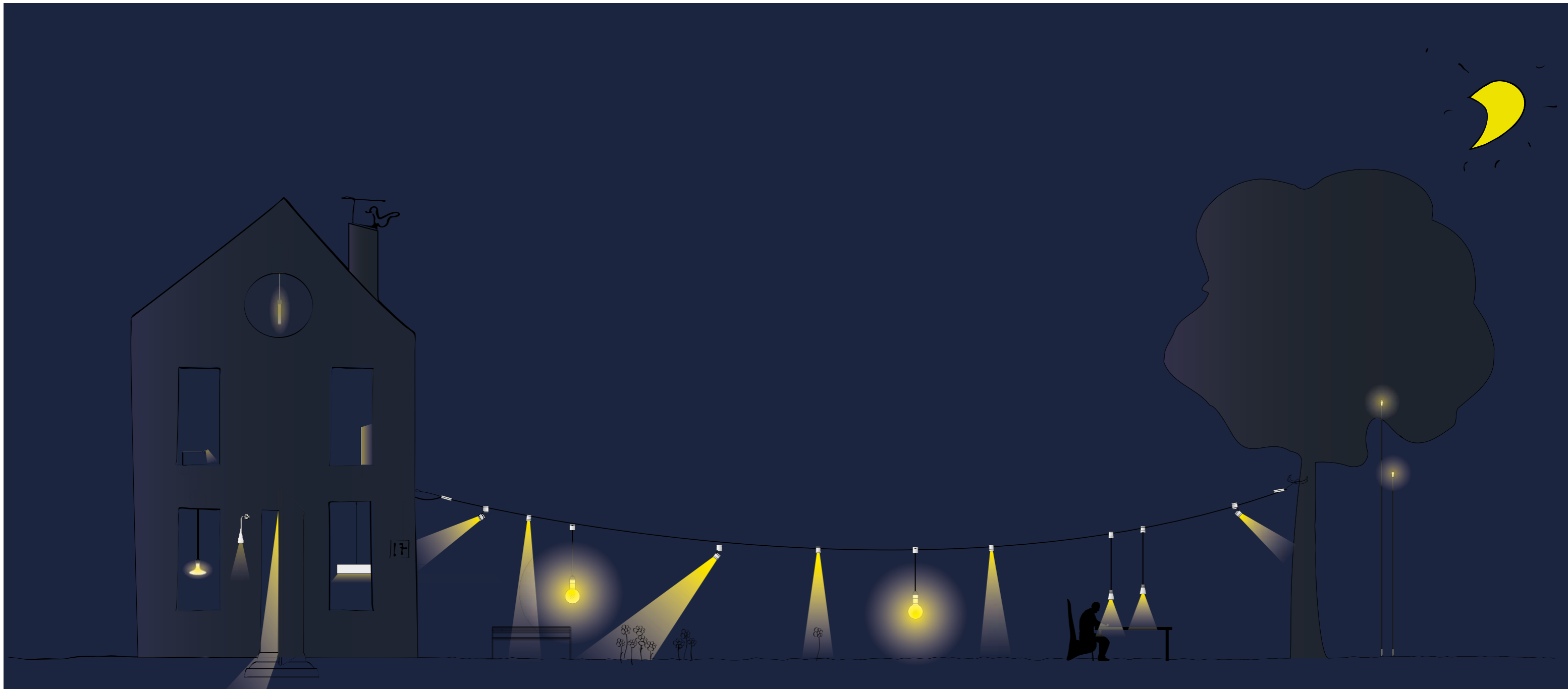

lettura delle tabelle tecniche how to read technical tables

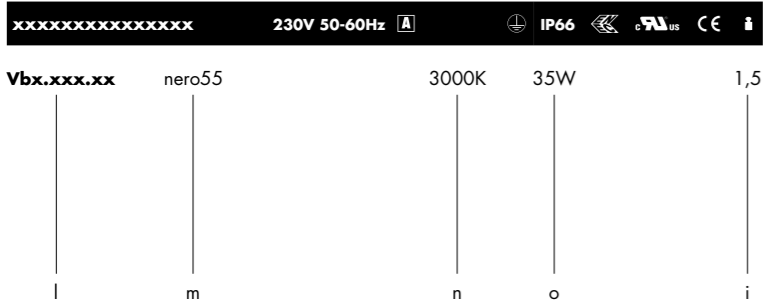
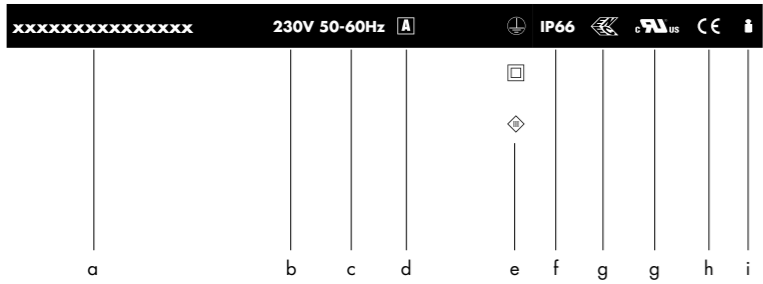

componenti. components. IK10 CE

accessori. accessories. IK10 CE

1	2	3	4	5	6	7	8	9	
Ra	R9	ies tm-30		sdc	mA	V _{f (min)}	lm	W	lm/W
98	98	Rf 96	Rg 103	step 1	350	27,6	1240	9,7	128
					500	27,9	1580	14,0	113
xm000	les19	Ta25 °C	vita media · average life			70000 h	L80	B10	
10	11						12	13	

bandella tecnica. posizioni standard simbologie.
data plate. standard arrangement of symbols.

a	nome apparecchio di illuminazione · light fitting name
b	tensione di alimentazione · supply rating (Volt)
c	frequenza di alimentazione · supply frequency (Hertz)
d	alimentatore incluso o escluso · power supply included or not included
e	classe di isolamento · insulation class
f	grado di protezione · protection degree
g	marchio di certificazione · safety and quality standards certification
h	conforme alle direttive europee produced in compliance with EC directives
i	peso netto · net weight (kg)
l	codice · code
m	finitura · finish
n	temperatura colore sorgente elettronica colour temperature led source (Kelvin)
o	potenza della sorgente · source power (Watt)

componenti. identifica tutti gli elementi indispensabili per la corretta funzionalità e installazione dell'apparecchio di illuminazione.
components. includes all items that are essential to the correct operation and installation of the light fitting.

accessori. si riferisce alle ulteriori parti installabili sull'apparecchio.
accessories. refers to items that can be added to the light fitting.



























1	indice di resa cromatica · colour rendering index
2	indice di resa del rosso · red colour rendering index
3	Rf indice di fedeltà colore · colour fidelity index Rg indice di saturazione colore · color gamut index
4	step di macadam · macadam step
5	corrente di alimentazione · power supply current
6	tensione di alimentazione · power supply voltage
7	flusso luminoso · light flux
8	potenza della sorgente · source power
9	efficienza della sorgente · source efficiency
10	codice sorgente elettronica Viabizzuno · Viabizzuno led source code
11	superficie emittente · light emitting surface (mm)
12	% flusso residuo a fine vita · end life % flux
13	% consentita sotto limite · allowed % under limit

gradi di protezione protection degrees

IPX0	non protetto no protection	IK01	nessuna protezione no protection
IPX1	protetto contro la caduta verticale di gocce d'acqua protected against water drops falling vertically	IK01	protetto contro l'energia d'urto 0,15J protected against collision energy
IPX2	protetto contro la caduta di gocce con inclinazione max 15° protected against water drops max inclination 15°	IK02	protetto contro l'energia d'urto 0,2J protected against collision energy
IPX3	protetto contro la caduta di gocce con inclinazione max 60° protected against water drops max inclination 60°	IK03	protetto contro l'energia d'urto 0,35J protected against collision energy
IPX4	protetto contro spruzzi d'acqua protected against sprinkling water	IK04	protetto contro l'energia d'urto 0,5J protected against collision energy
IPX5	protetto contro getti d'acqua protected against water jets	IK05	protetto contro l'energia d'urto 0,7J protected against collision energy
IPX6	protetto contro inondazioni protected against flooding	IK06	protetto contro l'energia d'urto 1J protected against collision energy
IPX7	per breve immersione protected against brief immersions	IK07	protetto contro l'energia d'urto 2J protected against collision energy
IPX8	per immersione prolungata protected against long immersion	IK08	protetto contro l'energia d'urto 5J protected against collision energy
IPX9	per immersione prolungata protected against long immersion	IK09	protetto contro l'energia d'urto 10J protected against collision energy
IPX10	per immersione prolungata protected against long immersion	IK10	protetto contro l'energia d'urto 20J protected against collision energy

IPOX	non protetto no protection
IP1X	contro corpi estranei >50 mm protection against solid objects
IP2X	contro corpi estranei >12 mm protection against solid objects
IP3X	contro corpi estranei >2,5 mm protection against solid objects
IP4X	contro corpi estranei >1 mm protection against solid objects
IP5X	protezione da polvere dust-protected
IP6X	stagno alla polvere dust-proof

legenda simboli symbols key

	<i>tavolo</i> · table
	<i>terra</i> · floor standing
	<i>soffitto</i> · ceiling
	<i>parete</i> · wall
	<i>sospensione</i> · suspension
	<i>binario</i> · track
	<i>incasso</i> · recessed
	<i>scomparsa totale</i> · fully concealed
	<i>segnaletica+emergenza</i> · signalling system+emergency
	<i>portatili autoalimentati a batteria</i> · portable self-powered with battery
	<i>sistemi</i> · systems
	<i>palo</i> · pole
	<i>paletto</i> · bollard
	<i>seduta</i> · sitting
	<i>disponibile su</i> · available on <i>Viabizzuno applight</i> <i>www.Viabizzuno.com</i> <i>Viabizzuno online</i>
	<i>classe I. solo isolamento fondamentale, le parti conduttrici accessibili sono collegate ad un conduttore di terra. messa a terra tassativa</i> class I. only basic insulation, accessible conductors are earthed. earthing compulsory
	<i>classe II. all'isolamento principale è aggiunto un secondo isolamento oppure ai due isolamenti è sostituito un isolamento rinforzato. messa a terra esclusa</i> class II. basic insulation plus second insulation or both are replaced by reinforced insulation. earthing excluded
	<i>classe III. alimentazione effettuata con bassissima tensione di sicurezza; sono escluse tensioni superiori a 50V-50Hz. messa a terra non prevista.</i> class III. very low safety supply tension; not to be used over 50V-50Hz. earthing excluded.
	<i>prodotto conforme alle direttive europee</i> · produced in compliance with ec directives
	<i>marchio di certificazione europea. certifica che il prodotto è conforme alle norme europee sulla sicurezza</i> component approved for north american market and suitable to be used and approved as part of a more complex system
	<i>componente certificato per il mercato nord americano idoneo ad essere utilizzato e valutato come parte di in un sistema più complesso</i> component approved for north american market and suitable to be used and approved as part of a more complex system
	<i>apparecchio di illuminazione approvato da kema</i> · kema approved light fitting
	<i>prodotto conforme agli standard presenti nel regno unito che regolamentano la sicurezza e la qualità dell'acqua</i> · product complies with uk standards set out by water regulations
	<i>apparecchio di illuminazione certificato secondo le normative vigenti in polonia che regolamentano i dispositivi di sicurezza antincendio</i> certified light fitting according to the regulations about devices for fire safety in force in poland
	<i>prodotto idoneo per essere commercializzato nel mercato cinese</i> · product suitable for the china market
	<i>prodotto finito idoneo per essere commercializzato nel mercato nord americano</i> · listed product suitable for the north american market
	<i>apparecchio di illuminazione certificato per il mercato cinese</i> light fitting certified for china market

	<i>vetro opalino</i> · opal glass
	<i>vetro sabbiato</i> · sanded glass
	<i>vetro nero fumè</i> · black smoke glass
	<i>vetro trasparente</i> · transparent glass
	<i>vetro bianco latte</i> · white milk glass
	<i>cristallo</i> · crystal
	<i>policarbonato opalino</i> · opal polycarbonate diffuser
	<i>carrabile</i> · drive over
	<i>alimentatore incluso</i> · power supply included
	<i>alimentatore escluso</i> · power supply not included
	<i>alimentatore remoto incluso</i> · remote power supply included
	<i>alimentatore elettronico con controllo intelligente incluso</i> · electronic power supply with smart control included
	<i>alimentatore elettronico con controllo intelligente incluso, da installare remoto</i> · electronic power supply with smart control included, to be installed remotely
	<i>alimentatore a spina incluso</i> · plug power supply included
	<i>trasformatore incluso</i> · transformer included
	<i>trasformatore escluso</i> · transformer not included
	<i>kit di cablaggio</i> · wiring kit
	<i>kit di cablaggio escluso</i> · wiring kit not included
	<i>lampadina con sorgente elettronica led, ad incandescenza, alogena o fluorescente inclusa.</i> bulb with led electronic source, incandescent, halogen or fluorescent included.
	<i>lampadina con sorgente elettronica led, ad incandescenza, alogena o fluorescente esclusa.</i> bulb with led electronic source, incandescent, halogen or fluorescent not included.
	<i>propulsore dinamico n55 incluso</i> · included
	<i>possibilità di combinazione tra interfaccia n55, propulsore dinamico n55 e lampadina n55</i> · possible combination between n55 interface, propulsore dinamico n55 and n55 bulb
	<i>attenzione: sorgente luminosa led. non guardare mai direttamente a occhio nudo</i> · attention: led light source. never look straight without eye protection
	<i>flicker free compatibile con fotocamere digitali</i> · flicker free digital camera friendly
l.d.	<i>luce diretta</i> · direct light
l.i.	<i>luce indiretta</i> · indirect light
.d1	<i>dimmerazione 1-10V</i> · 1-10V dimmable
.d2	<i>dimmerazione dali</i> · dimmable dali
.SA	<i>kit luce + emergenza sempre accese. attenzione: non è possibile installare nelle cassaforme laterizio</i> light kit + permanently lit emergency lamp. please note: cannot be installed in brickwork housing
.SE	<i>solo emergenza sempre accesa. attenzione: non è possibile installare nelle cassaforme laterizio</i> permanently lit emergency lamp only. please note: cannot be installed in brickwork housing
	<i>peso netto</i> · net weight (kg)