



*Viabizzuno strada principale della frazione di bizzuno in provincia di ravenna dove tra la casa del popolo e la parrocchia, al n°17, sono nato il ventuno luglio millenovecentocinquantacinque. da qui nasce il nome della fabbrica di produzione fondata nel millenovecentonovantaquattro rappresentata da uno spazio bianco attraversato da due linee. una verticale, rigorosa, essenziale, equilibrata: la luce per la luce; ed una inclinata, irriverente nello spazio, ironica, fuori dagli schemi: la luce per la forma. distinte ma complementari si fondono in un unico nome: Viabizzuno.*

*marionanni*

Viabizzuno is the name of the main road of the small village bizzuno located in the province of ravenna, where I was born on the twenty-first july nineteenfiftyfive at n°17, between the 'casa del popolo' and the local parish church. from here the name of the factory founded in nineteen ninety-four represented by a white space intersected by two lines. one vertical, well balanced, logical, essential: the light for the light. the other one dynamic, irreverent, ironic: the light for the form. separate and yet complementary they cast in the same name: Viabizzuno.

prodotto  
product



schede tecniche  
technical data sheet



curve fotometriche  
photometric curves



modelli 3d per i tuoi render  
3d models for your render





**apparecchio di illuminazione modulare a sospensione, soffitto, tavolo e terra per interni IP20. realizzato in alluminio ossidato con cilindri in vetro rigato internamente. l'esclusivo sistema a catena brevettato Viabizzuno permette di personalizzare la geometria della lampada ottenendo infinite possibilità di soluzioni architettoniche.**

**modelli:**

**coppibartali a 4 tavolo, lunghezza 245mm h.385mm,  
coppibartali a 12 tavolo, lunghezza 765mm h.264mm,  
coppibartali a 24 tavolo, lunghezza 1545mm h.264mm,  
coppibartali a 4 parete, lunghezza 245mm h.385mm,  
coppibartali a 12 parete, lunghezza 785mm h.385mm,  
coppibartali a 24 sospensione, lunghezza 1545mm h.385mm,  
coppibartali a 48 sospensione, lunghezza 3105mm h.385mm,  
coppibartali a 72 sospensione, lunghezza 4655mm h.385mm,  
coppibartali c 24 elementi sospensione, Ø550mm h.385mm,  
coppibartali c 48 sospensione, Ø1045mm h.385mm,  
coppibartali c 72 sospensione, Ø1540mm h.385mm,  
ogni cilindro è cablato con sorgente elettronica 2700K 3W 287lm.**

**modello coppibartali a 4 tavolo con alimentatore 100-240V 48Vdc a spina incluso,  
modelli coppibartali a12 tavolo, a24 tavolo con alimentatore 240V 48Vdc incluso,  
modelli sospensione alimentatori in tensione costante 48Vdc esclusi.**

**accessori: rosoni di alimentazione**

**finiture: ottone ap-s.**

**personalizza la tua luce vai su [www.Viabizzuno.com](http://www.Viabizzuno.com)**

**IP20 rated suspension, ceiling, table and floor-standing light fitting for indoor use. made of oxidized aluminum with glass cylinders. the exclusive patented Viabizzuno chain system allow to personalize the light fitting geometry with unlimited possibility of architectural solutions.**

**versions:**

**coppibartali a 4 tavolo, 245mm h.385mm,  
coppibartali a 12 tavolo, 765mm h.264mm,  
coppibartali a 24 tavolo, 1545mm h.264mm,  
coppibartali a 4 parete, lunghezza 245mm h.385mm,  
coppibartali a 12 parete, lunghezza 785mm h.385mm,  
coppibartali a 24 sospensione, 1545mm h.385mm,  
coppibartali a 48 sospensione, 3105mm h.385mm,  
coppibartali a 72 sospensione, 4655mm h.385mm,  
coppibartali c 24 sospensione, Ø550mm h.385mm,  
coppibartali c 48 sospensione, Ø1045mm h.385mm,  
coppibartali c 72 sospensione, Ø1540mm h.385mm,  
each cylinder is wired with 2700K 3W 287lm led source.**

**modello coppibartali a 4 tavolo 100-240V 48Vdc power supply with plug included,  
modelli coppibartali a12 tavolo, a24 tavolo 240V 48Vdc power supply with plug included,  
modelli sospensione 48Vdc constant voltage power supply not included.**

**accessories: ceiling roses**

**finishes: ottone ap-s.**

**customize your light visit [www.Viabizzuno.com](http://www.Viabizzuno.com)**

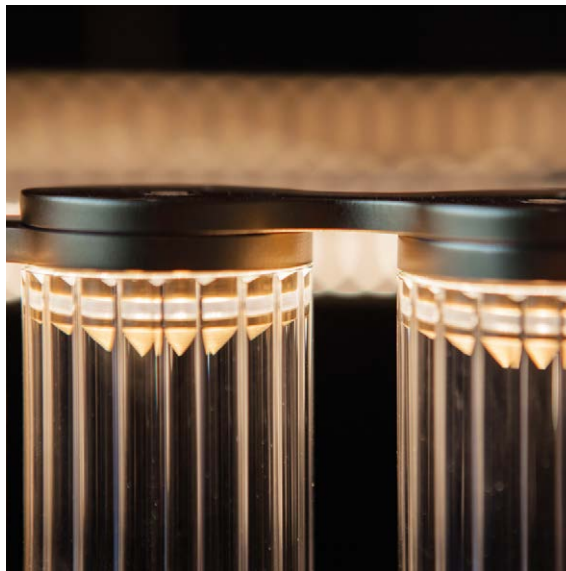



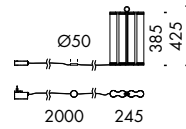

**coppibartali a 4 tavolo** 100-240V 50-60Hz AS IP20 CE i

**Vb2.636.01** ottone ap-s vetro pirex · glass 2700K 4x3W 3

Ra	R9	ies tm-30		sdc	mA	V <sub>f(min)</sub>	lm	W	lm/W
98	95	Rf 95	Rg 100	step 2	175	17,1	1148	12	96
cd032-4	les6	Ta25 °C		vita media · average life		50000 h	L80	B10	

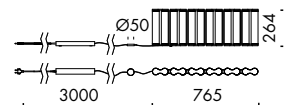

**coppibartali a 12 tavolo** 240V 50-60Hz A IP20 CE i

**Vb2.636.03** ottone ap-s vetro pirex · glass 2700K 12x3W 12

Ra	R9	ies tm-30		sdc	mA	V <sub>f(min)</sub>	lm	W	lm/W
98	95	Rf 95	Rg 100	step 2	175	17,1	3444	36	96
cd032-12	les6	Ta25 °C		vita media · average life		50000 h	L80	B10	

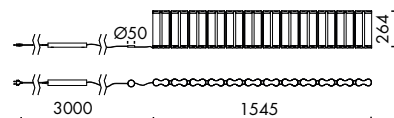

**coppibartali a 24 tavolo** 240V 50-60Hz A IP20 CE i

**Vb2.636.05** ottone ap-s vetro pirex · glass 2700K 24x3W 19

Ra	R9	ies tm-30		sdc	mA	V <sub>f(min)</sub>	lm	W	lm/W
98	95	Rf 95	Rg 100	step 2	175	17,1	6888	72	96
cd032-24	les6	Ta25 °C		vita media · average life		50000 h	L80	B10	



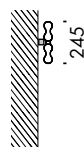
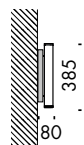

**coppibartali a 4 parete** 240V 50-60Hz  IP20    

**Vb5.636.01** ottone ap-s vetro pirex · glass 2700K 4x3W 1

Ra	R9	ies tm-30		sdc	mA	V <sub>f</sub> (min)	lm	W	lm/W
98	95	Rf 95	Rg 100	step 2	175	17,1	1148	12	96
cd0324	les6 ● Ta25 °C		vita media · average life		50000 h	L80 B10			



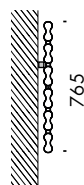
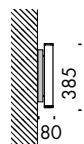

**coppibartali a 12 parete** 240V 50-60Hz IP20

**Vb5.636.03** ottone ap-s vetro pirex · glass 2700K 12x3W 3

Ra	R9	ies tm-30		sdc	mA	V <sub>f</sub> (min)	lm	W	lm/W
98	95	Rf 95	Rg 100	step 2	175	17,1	3444	36	96
cd032-12	les6	Ta25 °C		vita media · average life		50000 h	L80	B10	







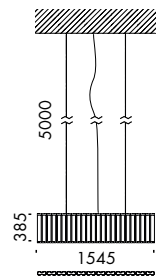

**coppibartali a 24 sospensione** 48Vdc

**Vb8.636.21** ottone ap-s vetro pirex · glass 2700K 24x3W 18

Ra	R9	ies tm-30		sdc	mA	V <sub>f (min)</sub>	lm	W	lm/W
98	95	Rf 95	Rg 100	step 2	175	17,1	6888	72	96
cd032-24	les6 ● Ta25 °C		vita media · average life 50000 h L80 B10						

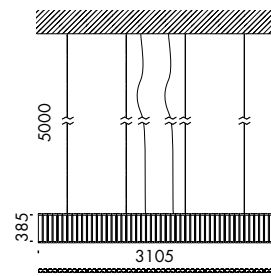

**coppibartali a 48 sospensione** 48Vdc

**Vb8.636.22** ottone ap-s vetro pirex · glass 2700K 48x3W 36

Ra	R9	ies tm-30		sdc	mA	V <sub>f (min)</sub>	lm	W	lm/W
98	95	Rf 95	Rg 100	step 2	175	17,1	13776	144	96
cd032-48	les6 ● Ta25 °C		vita media · average life 50000 h L80 B10						

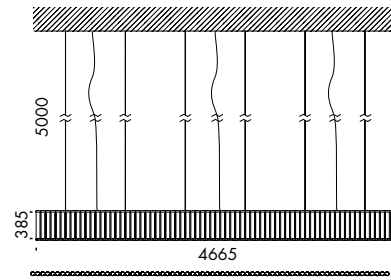

**coppibartali a 72 sospensione** 48Vdc

**Vb8.636.23** ottone ap-s vetro pirex · glass 2700K 72x3W 54

Ra	R9	ies tm-30		sdc	mA	V <sub>f</sub> (min)	lm	W	lm/W
98	95	Rf 95	Rg 100	step 2	175	17,1	20664	216	96
cd032-72	les6	Ta25 °C		vita media · average life		50000 h	L80	B10	

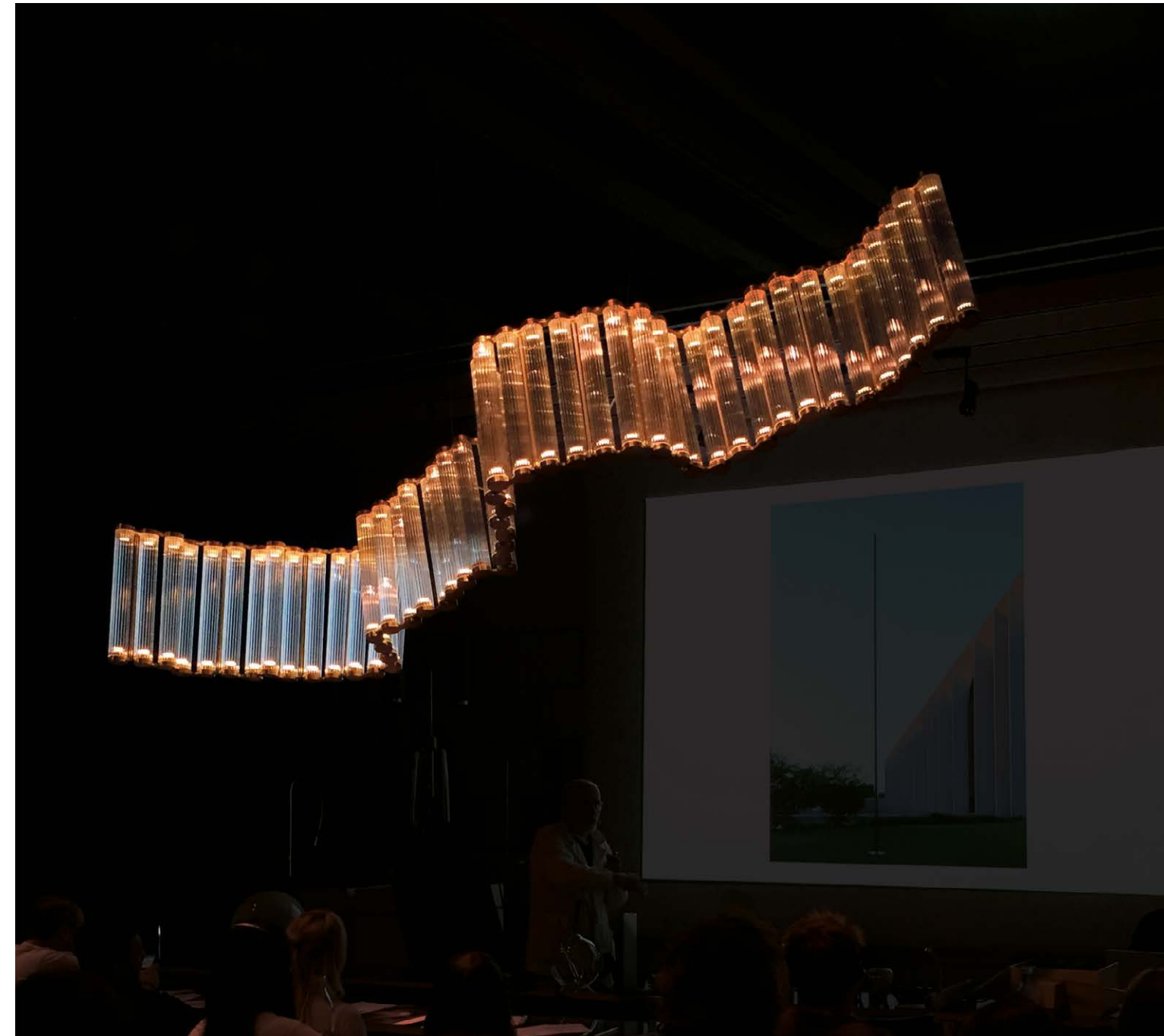







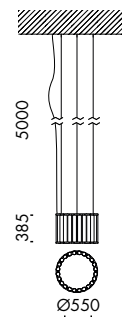

**coppibartali c 24 sospensione** 48Vdc

**Vb8.636.31** ottone ap-s vetro pirex · glass 2700K 24x3W 16

Ra	R9	ies tm-30		sdc	mA	V <sub>f (min)</sub>	lm	W	lm/W
98	95	Rf 95	Rg 100	step 2	175	17,1	6888	72	96
cd032-24	les6	Ta25 °C		vita media · average life		50000 h	L80	B10	

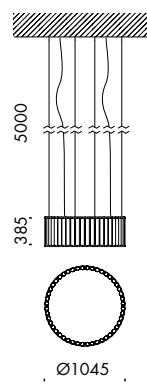

**coppibartali c 48 sospensione** 48Vdc

**Vb8.636.32** ottone ap-s vetro pirex · glass 2700K 48x3W 36

Ra	R9	ies tm-30		sdc	mA	V <sub>f (min)</sub>	lm	W	lm/W
98	95	Rf 95	Rg 100	step 2	175	17,1	13776	144	96
cd032-48	les6	Ta25 °C		vita media · average life		50000 h	L80	B10	

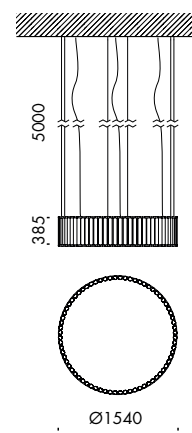

**coppibartali c 72 sospensione** 48Vdc

**Vb8.636.33** ottone ap-s vetro pirex · glass 2700K 72x3W 54

Ra	R9	ies tm-30		sdc	mA	V <sub>f (min)</sub>	lm	W	lm/W
98	95	Rf 95	Rg 100	step 2	175	17,1	20664	216	96
cd032-72	les6	Ta25 °C		vita media · average life		50000 h	L80	B10	







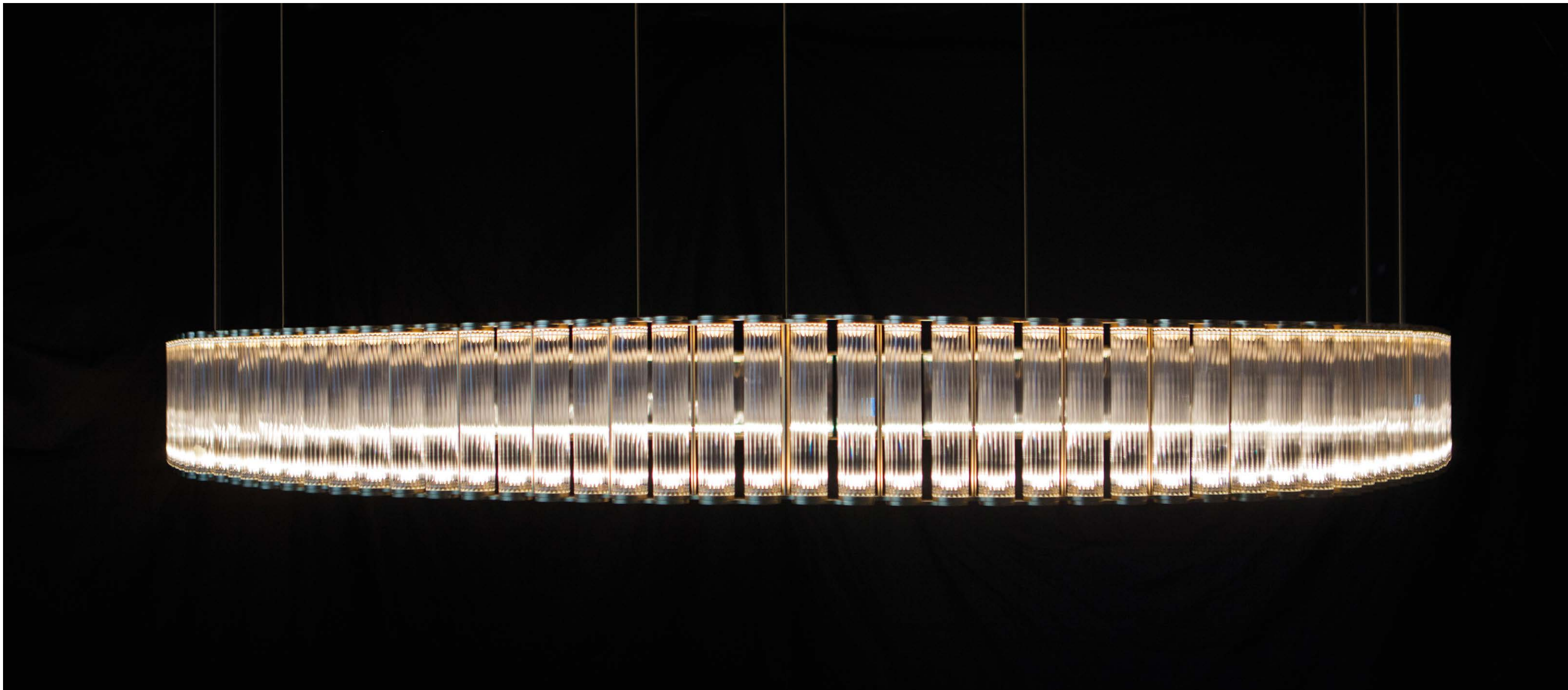



alcuni esempi di possibili configurazioni con geometrie chiuse · some examples of configurations with closed geometries

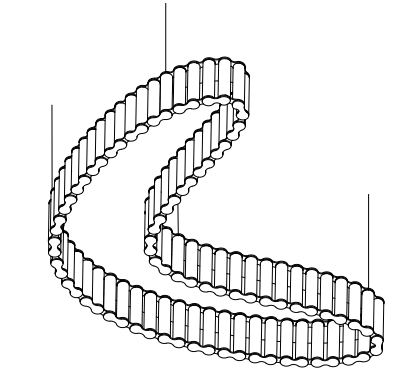
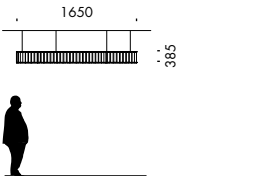
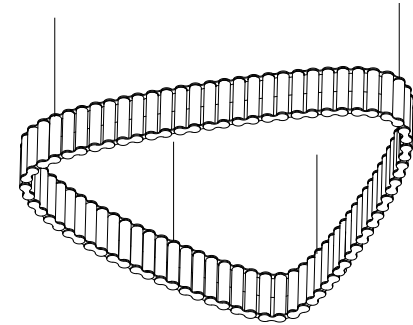
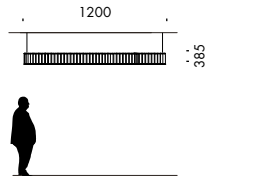
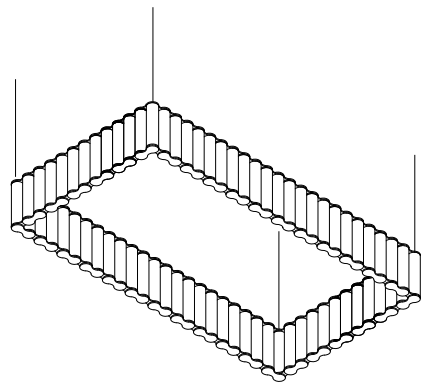
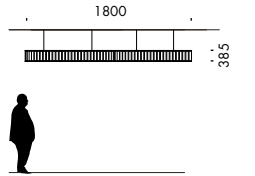
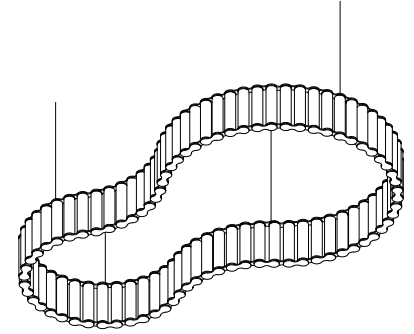
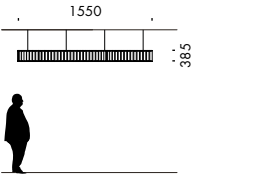
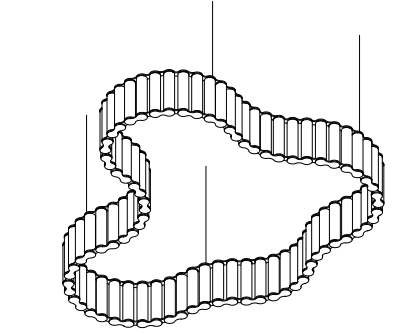
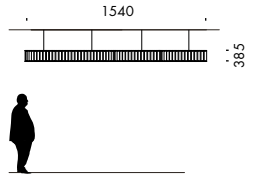
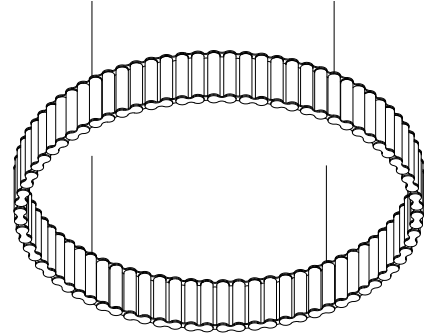

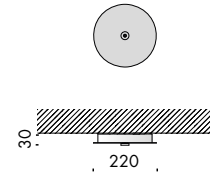
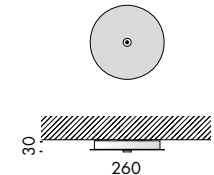
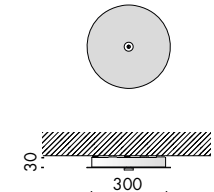
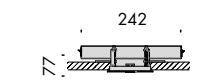
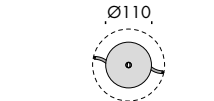
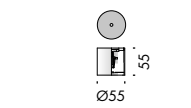
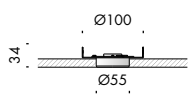
rosone di alimentazione. ceiling roses.		A	240V	☆ CE	i
	<b>Vb9.636.91</b> rosone soffitto ottone ap-s con alimentatore dimmer dali ottone ap-s ceiling rose with dimmer dali power supply			100W	2
	<b>Vb9.636.92</b> rosone soffitto ottone ap-s con alimentatore dimmer dali/pulsante ottone ap-s ceiling rose recessed with dimmer dali/push button power supply			200W	2,5
	<b>Vb9.636.93</b> rosone soffitto ottone ap-s con alimentatore dimmer dali/pulsante ottone ap-s ceiling rose recessed with dimmer dali/push button power supply			300W	3
	<b>Vb9.636.81</b> rosone incasso ottone ap-s ottone ap-s recessed ceiling rose			100W	2,3
	<b>Vb9.636.82</b> rosone incasso ottone ap-s ottone ap-s recessed ceiling rose			200W	2,3
	<b>Vb9.636.83</b> rosone incasso ottone ap-s ottone ap-s recessed ceiling rose			300W	2,3
rosone di alimentazione. ceiling roses.		A		☆ CE	i
	<b>Vb9.636.72</b> ottone ap-s				0,3
	<b>Vb9.580.73</b> scomparsa totale cartongesso fully concealed plasterboard				0,3



*personalizza la tua luce  
vai su [Viabizzuno.com](http://Viabizzuno.com)*

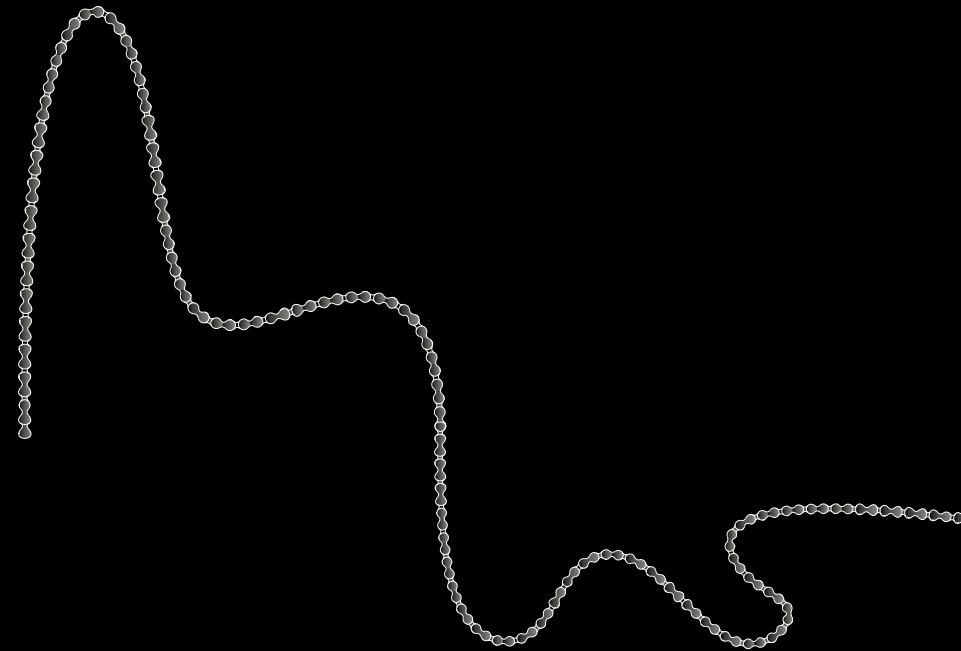

customize your light visit [Viabizzuno.com](http://Viabizzuno.com)

**1. personalizza le dimensioni**  
customize dimensions

**2. scegli il rosone di alimentazione**  
choose the ceiling rose

alcuni esempi di possibili configurazioni con dimensioni personalizzate - some examples of configurations with customized dimensions

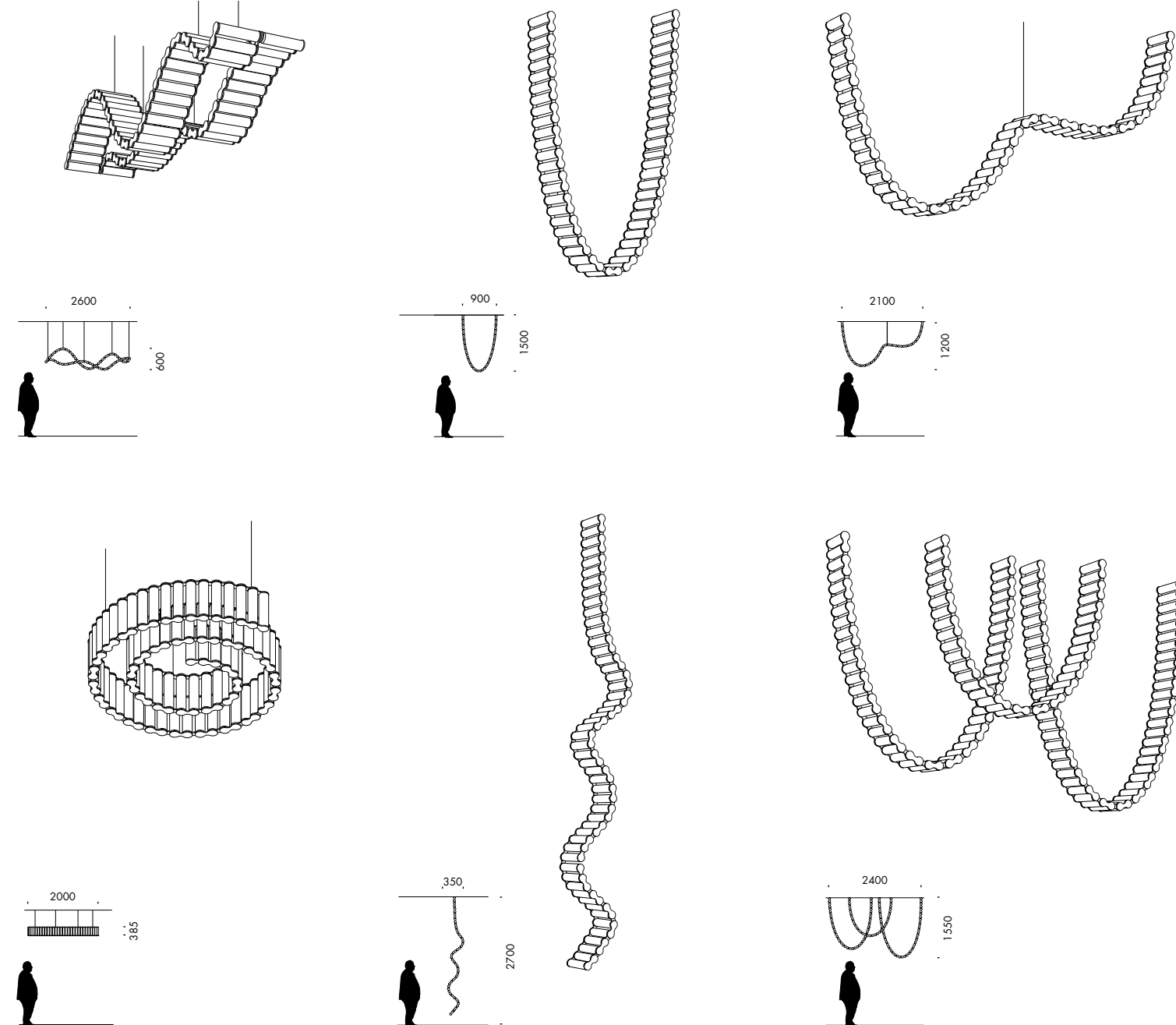



alcuni esempi di possibili configurazioni con dimensioni personalizzate - some examples of configurations with customized dimensions

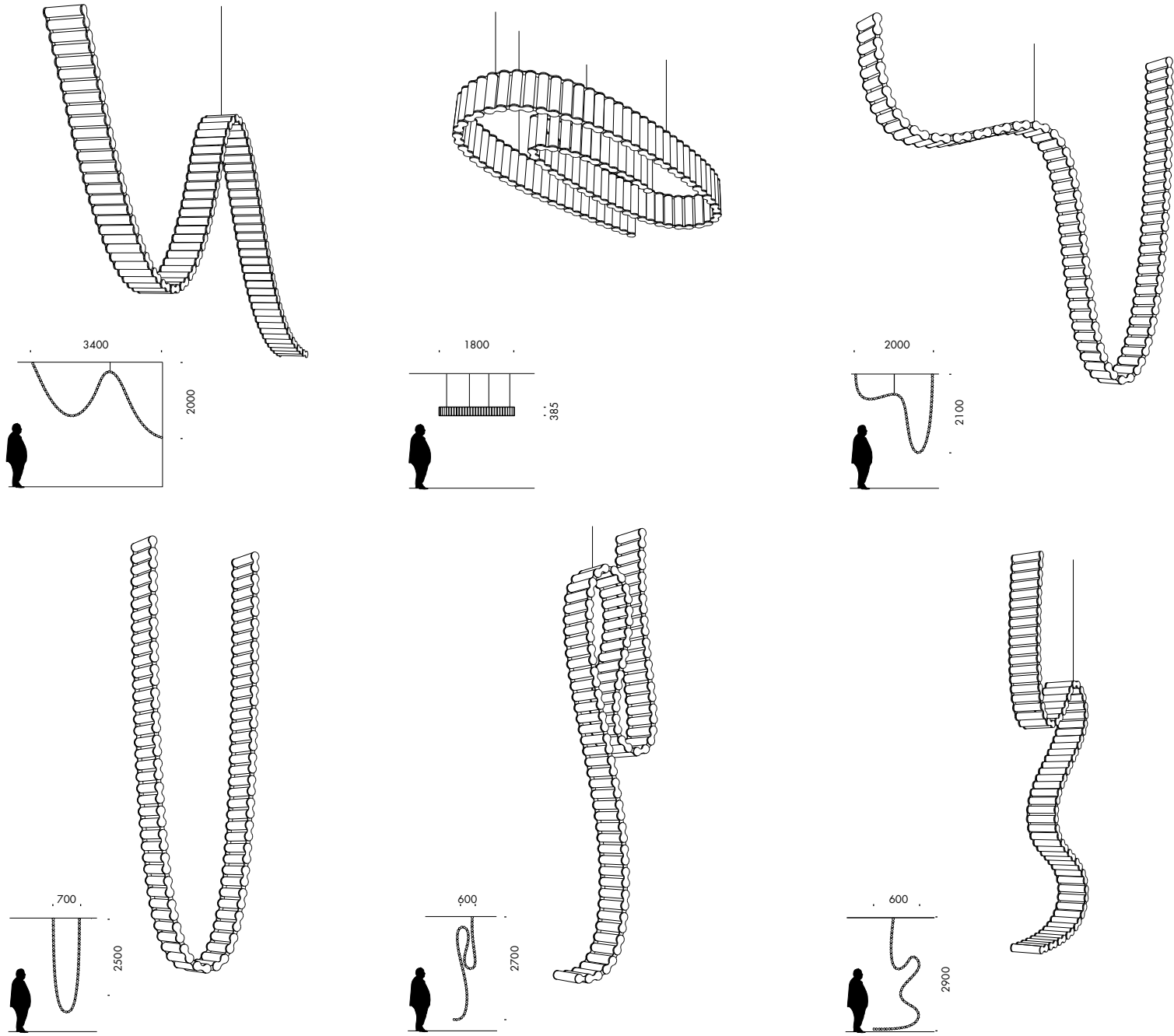





**lettura delle tabelle tecniche how to read technical tables**

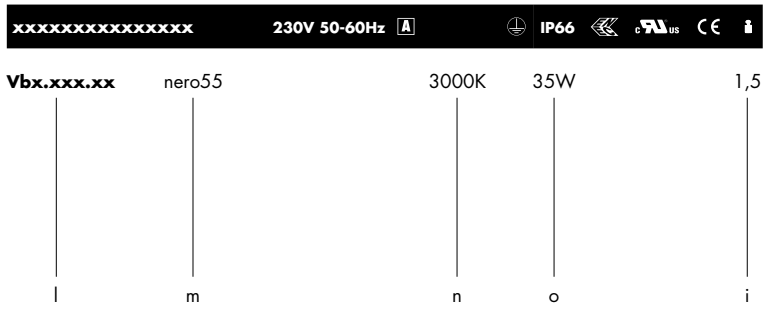
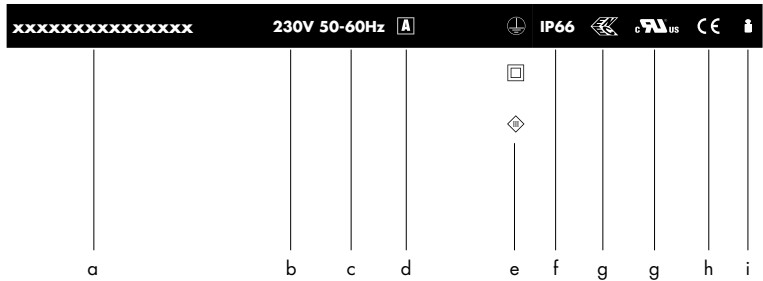

**componenti. components.** IK10 CE

**accessori. accessories.** IK10 CE

1	2	3	4	5	6	7	8	9	
Ra	R9	ies tm-30		sdcm	mA	V <sub>f (min)</sub>	lm	W	lm/W
98	98	Rf 96	Rg 103	step 1	350	27,6	1240	9,7	128
					500	27,9	1580	14,0	113
xm000	les19	Ta25 °C		vita media · average life		70000 h	L80 B10		
10	11					12	13		

bandella tecnica. posizioni standard simbologie.  
data plate. standard arrangement of symbols.

a	nome apparecchio di illuminazione · light fitting name
b	tensione di alimentazione · supply rating (Volt)
c	frequenza di alimentazione · supply frequency (Hertz)
d	alimentatore incluso o escluso · power supply included or not included
e	classe di isolamento · insulation class
f	grado di protezione · protection degree
g	marchio di certificazione · safety and quality standards certification
h	conforme alle direttive europee produced in compliance with EC directives
i	peso netto · net weight (kg)
l	codice · code
m	finitura · finish
n	temperatura colore sorgente elettronica colour temperature led source (Kelvin)
o	potenza della sorgente · source power (Watt)

componenti. identifica tutti gli elementi indispensabili per la corretta funzionalità e installazione dell'apparecchio di illuminazione.  
components. includes all items that are essential to the correct operation and installation of the light fitting.

accessori. si riferisce alle ulteriori parti installabili sull'apparecchio.  
accessories. refers to items that can be added to the light fitting.

1	indice di resa cromatica · colour rendering index
2	indice di resa del rosso · red colour rendering index
3	Rf indice di fedeltà colore · colour fidelity index Rg indice di saturazione colore · color gamut index
4	step di macadam · macadam step
5	corrente di alimentazione · power supply current
6	tensione di alimentazione · power supply voltage
7	flusso luminoso · light flux
8	potenza della sorgente · source power
9	efficienza della sorgente · source efficiency
10	codice sorgente elettronica Viabizzuno · Viabizzuno led source code
11	superficie emittente · light emitting surface (mm)
12	% flusso residuo a fine vita · end life % flux
13	% consentita sotto limite · allowed % under limit



























**gradi di protezione protection degrees**

IPX0	non protetto no protection	IK01	nessuna protezione no protection
IPX1	protetto contro la caduta verticale di gocce d'acqua protected against water drops falling vertically	IK01	protetto contro l'energia d'urto 0,15J protected against collision energy
IPX2	protetto contro la caduta di gocce con inclinazione max 15° protected against water drops max inclination 15°	IK02	protetto contro l'energia d'urto 0,2J protected against collision energy
IPX3	protetto contro la caduta di gocce con inclinazione max 60° protected against water drops max inclination 60°	IK03	protetto contro l'energia d'urto 0,35J protected against collision energy
IPX4	protetto contro spruzzi d'acqua protected against sprinkling water	IK04	protetto contro l'energia d'urto 0,5J protected against collision energy
IPX5	protetto contro getti d'acqua protected against water jets	IK05	protetto contro l'energia d'urto 0,7J protected against collision energy
IPX6	protetto contro inondazioni protected against flooding	IK06	protetto contro l'energia d'urto 1J protected against collision energy
IPX7	per breve immersione protected against brief immersions	IK07	protetto contro l'energia d'urto 2J protected against collision energy
IPX8	per immersione prolungata protected against long immersion	IK08	protetto contro l'energia d'urto 5J protected against collision energy
IPX9	per immersione prolungata protected against long immersion	IK09	protetto contro l'energia d'urto 10J protected against collision energy
IPX10	per immersione prolungata protected against long immersion	IK10	protetto contro l'energia d'urto 20J protected against collision energy

IPOX	non protetto no protection
IP1X	contro corpi estranei >50 mm protection against solid objects
IP2X	contro corpi estranei >12 mm protection against solid objects
IP3X	contro corpi estranei >2,5 mm protection against solid objects
IP4X	contro corpi estranei >1 mm protection against solid objects
IP5X	protezione da polvere dust-protected
IP6X	stagno alla polvere dust-proof



## legenda simboli symbols key

	<i>tavolo</i> · table
	<i>terra</i> · floor standing
	<i>soffitto</i> · ceiling
	<i>parete</i> · wall
	<i>sospensione</i> · suspension
	<i>binario</i> · track
	<i>incasso</i> · recessed
	<i>scomparsa totale</i> · fully concealed
	<i>segnaletica+emergenza</i> · signalling system+emergency
	<i>portatili autoalimentati a batteria</i> · portable self-powered with battery
	<i>sistemi</i> · systems
	<i>palo</i> · pole
	<i>paletto</i> · bollard
	<i>seduta</i> · sitting
	<i>disponibile su</i> · available on <i>Viabizzuno applight</i> <i>www.Viabizzuno.com</i> <i>Viabizzuno online</i>
	<i>classe I. solo isolamento fondamentale, le parti conduttrici accessibili sono collegate ad un conduttore di terra. messa a terra tassativa</i> class I. only basic insulation, accessible conductors are earthed. earthing compulsory
	<i>classe II. all'isolamento principale è aggiunto un secondo isolamento oppure ai due isolamenti è sostituito un isolamento rinforzato. messa a terra esclusa</i> class II. basic insulation plus second insulation or both are replaced by reinforced insulation. earthing excluded
	<i>classe III. alimentazione effettuata con bassissima tensione di sicurezza; sono escluse tensioni superiori a 50V-50Hz. messa a terra non prevista.</i> class III. very low safety supply tension; not to be used over 50V-50Hz. earthing excluded.
	<i>prodotto conforme alle direttive europee</i> · produced in compliance with ec directives
	<i>marchio di certificazione europea. certifica che il prodotto è conforme alle norme europee sulla sicurezza</i> component approved for north american market and suitable to be used and approved as part of a more complex system
	<i>componente certificato per il mercato nord americano idoneo ad essere utilizzato e valutato come parte di in un sistema più complesso</i> component approved for north american market and suitable to be used and approved as part of a more complex system
	<i>apparecchio di illuminazione approvato da kema</i> · kema approved light fitting
	<i>prodotto conforme agli standard presenti nel regno unito che regolamentano la sicurezza e la qualità dell'acqua</i> · product complies with uk standards set out by water regulations
	<i>apparecchio di illuminazione certificato secondo le normative vigenti in polonia che regolamentano i dispositivi di sicurezza antincendio</i> certified light fitting according to the regulations about devices for fire safety in force in poland
	<i>prodotto idoneo per essere commercializzato nel mercato cinese</i> · product suitable for the china market
	<i>prodotto finito idoneo per essere commercializzato nel mercato nord americano</i> · listed product suitable for the north american market
	<i>apparecchio di illuminazione certificato per il mercato cinese</i> light fitting certified for china market

	<i>vetro opalino</i> · opal glass
	<i>vetro sabbiato</i> · sanded glass
	<i>vetro nero fumè</i> · black smoke glass
	<i>vetro trasparente</i> · transparent glass
	<i>vetro bianco latte</i> · white milk glass
	<i>cristallo</i> · crystal
	<i>policarbonato opalino</i> · opal polycarbonate diffuser
	<i>carrabile</i> · drive over
	<i>alimentatore incluso</i> · power supply included
	<i>alimentatore escluso</i> · power supply not included
	<i>alimentatore remoto incluso</i> · remote power supply included
	<i>alimentatore elettronico con controllo intelligente incluso</i> · electronic power supply with smart control included
	<i>alimentatore elettronico con controllo intelligente incluso, da installare remoto</i> · electronic power supply with smart control included, to be installed remotely
	<i>alimentatore a spina incluso</i> · plug power supply included
	<i>trasformatore incluso</i> · transformer included
	<i>trasformatore escluso</i> · transformer not included
	<i>kit di cablaggio</i> · wiring kit
	<i>kit di cablaggio escluso</i> · wiring kit not included
	<i>lampadina con sorgente elettronica led, ad incandescenza, alogena o fluorescente inclusa.</i> bulb with led electronic source, incandescent, halogen or fluorescent included.
	<i>lampadina con sorgente elettronica led, ad incandescenza, alogena o fluorescente esclusa.</i> bulb with led electronic source, incandescent, halogen or fluorescent not included.
	<i>propulsore dinamico n55 incluso</i> · included
	<i>possibilità di combinazione tra interfaccia n55, propulsore dinamico n55 e lampadina n55</i> · possible combination between n55 interface, propulsore dinamico n55 and n55 bulb
	<i>attenzione: sorgente luminosa led. non guardare mai direttamente a occhio nudo</i> · attention: led light source. never look straight without eye protection
	<i>flicker free compatibile con fotocamere digitali</i> · flicker free digital camera friendly
<b>l.d.</b>	<i>luce diretta</i> · direct light
<b>l.i.</b>	<i>luce indiretta</i> · indirect light
<b>.d1</b>	<i>dimmerazione 1-10V</i> · 1-10V dimmable
<b>.d2</b>	<i>dimmerazione dali</i> · dimmable dali
<b>.SA</b>	<i>kit luce + emergenza sempre accese. attenzione: non è possibile installare nelle cassaforme laterizio</i> light kit + permanently lit emergency lamp. please note: cannot be installed in brickwork housing
<b>.SE</b>	<i>solo emergenza sempre accesa. attenzione: non è possibile installare nelle cassaforme laterizio</i> permanently lit emergency lamp only. please note: cannot be installed in brickwork housing
	<i>peso netto</i> · net weight (kg)