



FENSTERTECHNIK  
TÜRTECHNIK  
AUTOMATISCHE EINGANGSSYSTEME  
GEBÄUDEMANAGEMENTSYSTEME

MORE THAN  
**60**  
YEARS **LIFT & SLIDE**  
EXPERTISE



Photo: Getty Images

WINDOW TECHNOLOGY

**Lift&Slide Fascination –  
reinvented by the inventor**

Securing technology for you





# FASCINATION & SLIDE

# LIFE

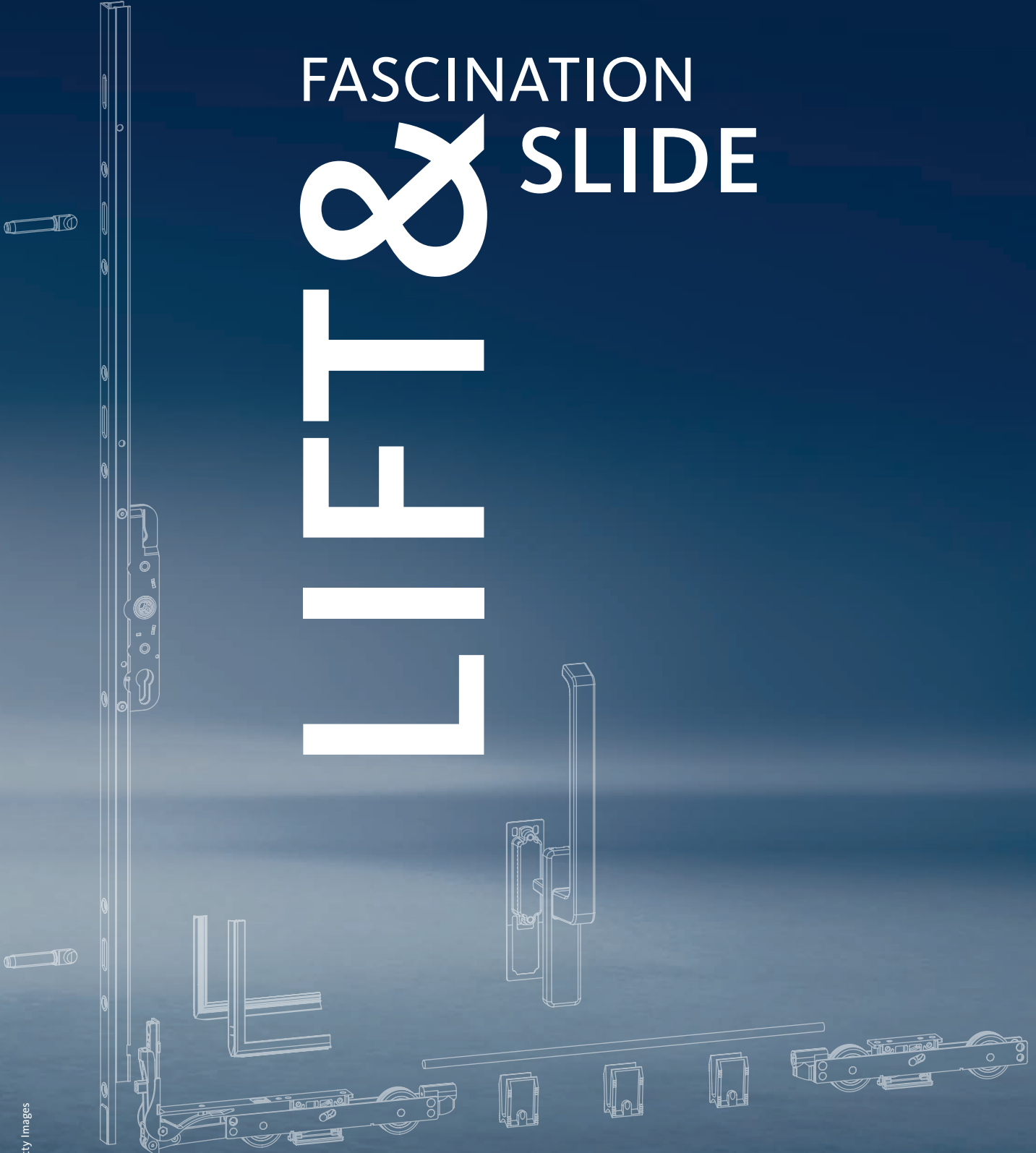

## REINVENTED BY THE INVENTOR

Since inventing the Lift&Slide system in 1952, Gretsch-Unitas group has set standards that have had a profound effect on the market up to the present day. Owing to systematic further development of the Lift&Slide hardware, an all-encompassing highly diverse range of solutions, also system-related, is now available for the most common profile materials.

All hardware is burglar-inhibiting according to EN 1627, tested up to resistance class RC 3 and certified for retrofitting according to DIN 18104-2. In addition, a GU-thermostep threshold which is flush with the floor can be fitted to Lift&Slide elements. The elements can also be made entirely barrier free using the HS ePOWER motor-driven drive: the combination of threshold and drive offers outstanding comfort within the meaning of barrier-free solutions as defined by DIN 18040.

MORE THAN  
**60**  
YEARS

  
**LIFT  
&  
SLIDE**

**SLIDE**  
EXPERTISE

Considering it has more than 60 years of experience in developing and consolidating its expertise in the area of Lift&Slide technology, it is safe to say that Gretsch-Unitas group offers far more than just hardware solutions for large-format elements. Working closely with our customers, we provide system solutions tailored to individual requirements with the aim of crafting space with an unparalleled living feel.

# BASICS

## EXTENDED

- Moving large elements with unparalleled ease  
**Lift&Slide bogie**
- Extremely resilient and durable  
**Lift&Slide gear**
- Securely locked with RC 2/ RC 3 tested burglar inhibition  
**Stainless steel frame cam**
- Maximum tightness - simply install and done  
**90° corner gasket**
- Also freestanding locked and tight  
**L&S locking system for pattern G1, symmetrical**
- Universal solution for added convenience  
**Barrier-free threshold**
- Made to measure for on-the-spot installation  
**Pre-assembled GU-thermostep threshold**
- One-stop professional sealing  
**Structural connection for GU-thermostep thresholds**

# COMFORT

## MAXIMISED

### ACCESS COMFORT

- Makes light work of lifting heavy sashes  
**HS LiftUnit**
- Universal threshold solution for added convenience  
**Barrier-free threshold**
- Elegant, comfortable and barrier-free  
**HS ePOWER motor-driven drive**
- Added comfort and easy to retrofit  
**HS Master motor-driven drive**

### EASY OPERATION

- For rebound-free, controlled lowering of the sash  
**Handle damper**
- Reduces the operating force on the turn handle  
**Tension spring in Lift&Slide gear**
- Tight controlled closing, also for light window sashes  
**Lowering safeguard**
- Barrier-free in handle area  
**RONDO 400 mm extended handle**
- Moving large elements with the greatest of ease  
**Lift&Slide bogie**



## BURGLARY PROTECTED

- Open or locked, recognisable at a glance  
**Electronic locking monitoring with magnetic switch, VdS-tested**
- Anti-jimmy device, with secure grip  
**L&S meeting-stile security profile**
- A firm handle on security  
**DIRIGENT PZ ZA SK3 Lift&Slide turn handle**
- Anti-jimmy protection for sashes  
**Anti-jimmy device top horizontal**
- Open but still securely locked  
**Night ventilation for Lift&Slide doors**



## OPERATION SECURED

- Gentle braking operation  
**HS SilentClose**
- Reliable stopping before end position  
**HS StopUnit**
- A speed limit that makes sense  
**HS SpeedLimiter**
- For rebound-free lowering of the sash  
**Handle damper**
- Buffered stop without damage  
**Buffer S**



# VENTILATION

## OPTIMISED

- Open but still securely locked  
**Night ventilation for Lift&Slide doors**
- Effective and secure Lift&Slide night ventilation  
**Night ventilation frame cam and bottom keeper**



# DESIGN

## HONED TO PERFECTION







- Maximum glazing to maximise sense of space  
**Lift&Slide element with panoramic glazing**
- Moving as if by magic  
**Concealed top guide track**
- Comfortable operation and appealing design  
**Turn handles**
- Versatile and multi-facetted  
**Patterns A-L for systems up to 20 metres wide**
- Corner elegance  
**Lift&Slide element for 90° corner**
- Elegant, comfortable and barrier-free  
**HS ePOWER motor-driven drive**



# SERVICE

## INCREASED

- The basis for successful construction projects  
**Planning support**
- Comprehensive and technically up-to-date Tender-Text-Manager
- The right products in the right quantity  
**confiGurator**
- Provision of hardware data  
**Hardware data service**
- For straightforward planning  
**Free download**
- Information at the click of a mouse  
**Customer Information System**
- Maximum security as standard  
**Licenses and CE**
- First-hand practical knowledge  
**Seminars and training course**
- Fewer costs and legal peace of mind  
**In-house test centre**
- On-site service  
**Technical field staff**
- All you need for perfect planning  
**Hotline for architects**
- Service and maintenance  
**GU Automatic GmbH**

	<b>BASICS</b>	<b>4</b>		<b>OPERATION</b>	<b>30</b>
	Lift&Slide bogies	6		HS SilentClose	32
	Lift&Slide gears	7		HS StopUnit	33
	Stainless steel frame cams	8		HS SpeedLimiter	34
	90° gasket corner	8		Handle damper	34
	L&S locking system for pattern G1, symmetrical	9		Buffer S	35
	Thresholds	10			
	Barrier-free threshold	11		<b>VENTILATION</b>	<b>36</b>
	Pre-assembled GU-thermostep threshold for Lift&Slide elements	12		Night ventilation for Lift&Slide doors	38
	Structural connection for GU-thermostep thresholds	13		Night vent frame cam and bottom keeper	39
	<b>COMFORT</b>	<b>14</b>		<b>DESIGN</b>	<b>40</b>
	HS LiftUnit	16		Lift&Slide element with panoramic glazing	42
	Barrier-free threshold	17		Concealed top guide track	43
	HS ePOWER motor-driven drive	18		Turn handles	44
	HS Master motor-driven drive	19		Sash configurations Patterns A–L	46
	Handle damper	20		Lift&Slide element for 90° corner	48
	Tension spring in Lift&Slide gear	20		HS ePOWER motor-driven drive	49
	Lowering safeguard	21		<b>SERVICE</b>	<b>50</b>
	RONDO series extended handle	21		Planning support	52
	Lift&Slide bogies	22		Tender-Text-Manager	52
	<b>BURGLARY</b>	<b>24</b>		configURator	52
	Electronic locking monitoring with magnetic switch	26		Hardware data service	53
	L&S meeting-stile security profile	26		Free download	53
	DIRIGENT Lift&Slide turn handle PZ ZA SK3	27		Customer Information System	53
	Anti-jemmy device top horizontal	28		Licences and CE	54
	Night ventilation for Lift&Slide doors	29		Seminars and training courses	54
				In-house test centre	55
				Technical field staff	55
				Hotline for architects	55
				Service and maintenance	55

# BASICS

## EXTENDED



As inventor and leading specialist partner for Lift&Slide hardware, Gretsch-Unitas has built a formidable reputation as provider of technically optimised solutions, many of which are unique on the market. The overriding objective is to maximise the benefits for users and window/door fabricators alike.

Even the standard components are impressive owing to a well thought out design and construction which ensures problem-free functionality of all Lift&Slide components which normally lasts the entire lifetime of the Lift&Slide element. Users enjoy exceptional ease of movement and running smoothness of the sliding elements, straightforward operation when opening and closing and well thought-out barrier-free thresholds.

We ensure straightforward, time-saving and safe assembly with fabricator-friendly components, a comprehensive range of fixing accessories and support with planning and design of each Lift&Slide element tailored to individual requirements.

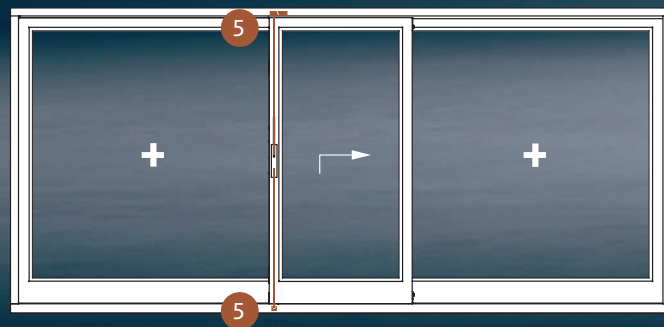

- 1 Moving large elements with the greatest of ease  
**Lift&Slide bogies**
- 2 Extremely resilient and durable  
**Lift&Slide gears**

- 3 Securely locked with RC 2/RC 3-tested burglar inhibition  
**Stainless steel frame cams**
- 4 Maximum tightness, also in the smallest corner  
**90° gasket corner**





5 Also freestanding locked and tight  
**L&S locking system for pattern G1, symmetrical**

6 Universal solution for added convenience  
**Barrier-free threshold**

**Exclusively**  
available only from  
Gretsch-Unitas

7 Made to measure for on-the-spot installation  
**Pre-assembled GU-thermostep threshold for Lift&Slide elements**

8 Professional sealing as a one-stop service  
**Structural connection for GU-thermostep thresholds**



## 1 Lift&Slide bogies

### Moving large elements with the greatest of ease

Gretsch-Unitas Lift&Slide bogies are impressive due to their well thought out design and outstanding product quality. They guarantee ease of operation and comfortable running smoothness throughout the whole application range. The bogie support which is integrated as standard into the bogie ensures uniform load distribution of the window sash when closed. Ball bearing-supported, plastic-coated rollers ensure outstanding running smoothness and ease of movement of the sliding sash.

### Good to know:

- The GU-934 bogies are used as standard with sash weights up to 350 kg and can be used with sash weights up to 600 kg in combination with the HS LiftUnit Heavy with tandem bogie
- The GU-937 bogies have an application range of up to 200 kg as the standard version and up to 400 kg as tandem bogie
- Outstanding manufacturing quality ensures durability in every application range
- Functional endurance tested with min. 25,000 cycles and max. sash weight according to EN 13126-16

### Benefits for user:

- Satisfies the highest expectations in terms of comfort and running smoothness, also with large-format heavy elements
- Outstanding manufacturing quality ensures durability which is second to none
- Innovative bogie design results in extremely low operating forces and outstanding running characteristics

GU-934 Lift&Slide bogie with ferGUard\*silver finish

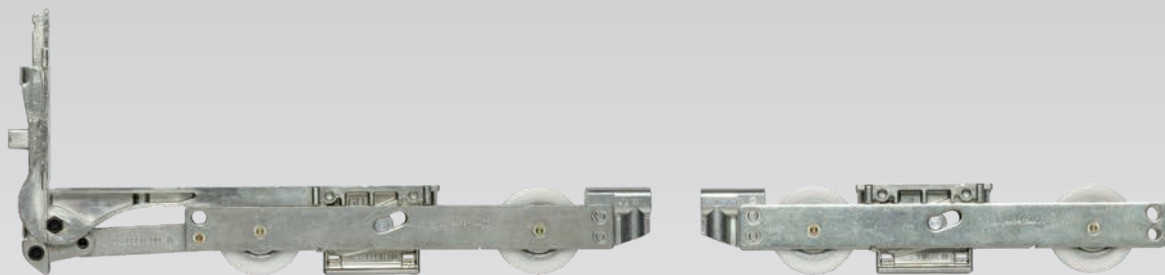

GU-937 Lift&Slide bogie with ferGUard\*silver finish



## 2 Lift&Slide gears

### Extremely resilient and durable

The Lift&Slide gear is the pivotal point of Lift&Slide elements and effects opening and closing of the sliding sash via the hardware. Gretsch-Unitas Lift&Slide gears are known for their precision and quality, outstanding resilience and durability. Their design has been optimised over many decades and sets standards in the market.

All drive-gears come with the SKG\*\* approval as standard and are supplied ex works with a PC hole. This means that a profile cylinder can also subsequently be installed in combination with a turn handle with PC hole, without having to replace the gear.

The follower of the turn handle is equipped with a plastic insert as standard which receives the square spindle of the turn handle without play and therefore avoids noise during operation and also signs of wear.

### Good to know:

- Prepared for profile cylinder
- With SKG\*\* approval as standard
- Durable and exceptionally resilient in every application range
- Tension spring, handle damper and locking monitoring system can be easily installed, or subsequently retrofitted, in every drive-gear
- Functional endurance tested with min. 25,000 cycles and max. sash weight according to EN 13126-16
- Prepared for additional locking positions

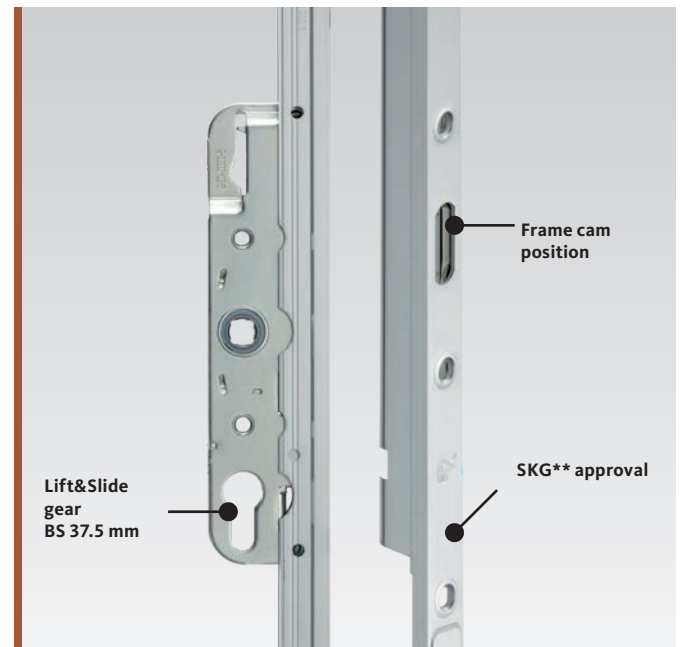

### Benefits for user:

- Allows a profile cylinder to be subsequently installed
- Outstanding durability and resilience in every application range



### 3 Stainless steel frame cams

#### Securely locked with RC 2/RC 3/SKG\*\*-tested burglar inhibition

The frame cam is screwed into the frame element at two or more points. When closed, the cam engages with the hardware of the sliding panel and holds it securely in the locked position. It is therefore an important link between the frame and window sash which, in addition to burglar inhibition, also ensures the necessary gasket pressure between the frame and sash. Depending on the element, burglar inhibition up to RC 2/RC 3 is easily achieved with two or more frame cams.

#### Good to know:

- Very simple installation
- Adjustable gasket pressure
- High stability
- Can be screwed in mechanically using the attachment for cordless screwdriver

#### Benefits for user:

- High degree of element security, standard version already certified to RC 2/SKG\*\*
- Version 1/S prepared for additional night ventilation function

#### Two versions of the GU frame cams are available:

Frame cam 1: for all standard applications, with locking system on the door frame



Frame cam 1/S: for an additional night ventilation position, with locking system on the door frame

### 4 90° gasket corner

#### Maximum tightness, also in the tiniest corner

The gasket profile seals the sliding sash vertically against the door frame at the side and horizontally at the bottom along the threshold. In this situation, the two 90° corners at the bottom form a critical contact surface. What others regard as a weakness, the gasket corner by Gretsch-Unitas turns into an advantage. This is because the 90° corner is already pre-assembled in the gasket profile and is designed to be installed directly in the sliding sash. Shortening to ensure a precise fit, mitre cutting and gluing of the two gasket halves can therefore be entirely omitted. The pre-assembled corner gasket can be conveniently and easily fitted in the groove provided in the sliding sash in only one work step.

#### Good to know:

- Simple and easy installation
- No gluing of corner area required
- Outstanding tightness and neatness of installation due to pre-assembled vulcanised corner area
- Available with or without silicone coating

#### Benefits for user:

- The seal ensures a high degree of tightness, also in the vulnerable corner area and, thanks to excellent material characteristics, it is highly elastic and therefore lasts a long time

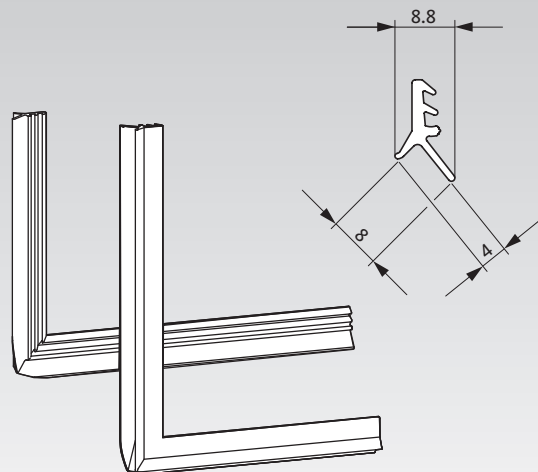

## 5 L&S locking system for pattern G1, symmetrical

Exclusively  
available only from  
Gretsch-Unitas

### Also freestanding locked and tight

With Lift&Slide elements arranged according to pattern G1, two fixed-glazed sashes are installed in the outer layer of the element – to the left and right of the sliding sash. The sliding sash is located in the centre of the element and, contrary to usual practice, cannot interlock with the frame cam in the door frame on the handle side via the Lift&Slide gear. The L&S locking system for pattern G1 is an effective solution by Gretsch-Unitas for secure locking upwards into the frame and downwards into the threshold.

With this system, the locking element moves up into a top keeper, which is installed in the top guide track. The L&S locking system is locked in position at the bottom via the bogie in a bottom keeper which is attached to the roller track. This ingenious solution means that the sliding sash is securely locked at two different points. Moreover, the locking components in this version generate additional gasket pressure which further enhances the tightness.

### Good to know:

- Available exclusively from Gretsch-Unitas
- Fast and straightforward installation, thanks to pre-assembled components

### Benefits for user:

- Not visible, due to concealed installation in the window sash
- Large wide glass surfaces with few vertical profiles can be securely implemented

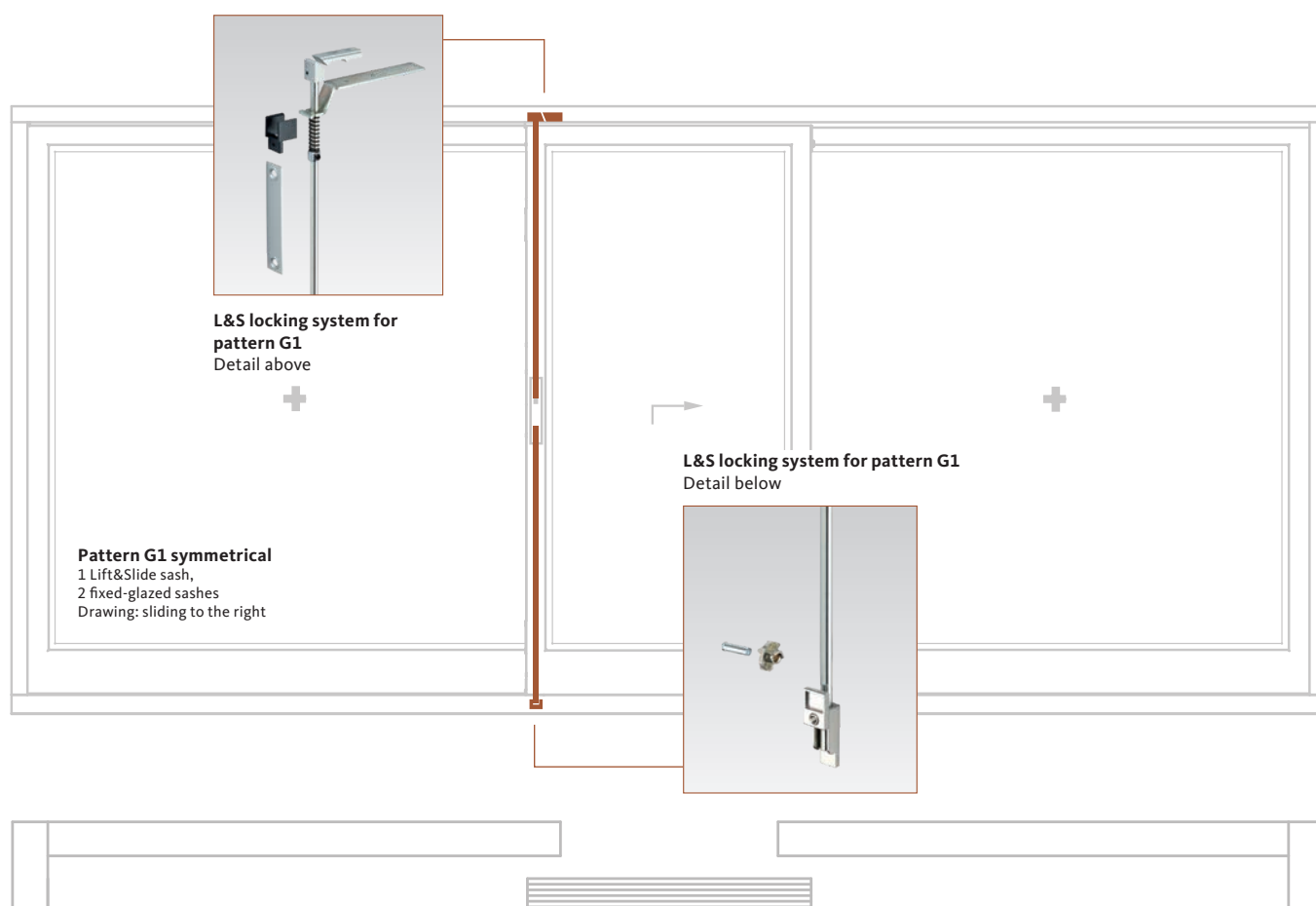



# Thresholds

### Sophisticated solutions for contemporary Lift&Slide elements

The threshold is an essential component of a Lift&Slide element. Due to the thermal break interrupting the heat flow from inside to outside, substantial energy savings can be achieved. Furthermore, all thresholds by Gretsche-Unitas are characterised by their high stability. They demonstrate how adapting perfectly to the market demands of our customers achieves outstanding results. All GU threshold solutions are CE- and RC 2-certified and offer outstanding comfort and accessibility. Barrier-free versions are of course also available.

Energy-efficient installation of doors and balcony doors can be achieved using the CE-certified, thermally-broken GU system thresholds. They are adapted to various profile systems and, due to the wide range of overall depths, are suitable for nearly all installation situations in new buildings

and renovation projects. All threshold solutions by Gretsche-Unitas are technically designed so that the threshold is flush with the side door frame on the inside and outside which provides the optimum basis for the structural connection.

Gretsche-Unitas thresholds can be fabricated using existing machines and no special tools are required. The materials plastic and aluminium can be fully recycled and fed back into the reusable materials cycle.





## 6 Barrier-free threshold

### Universal threshold solution for added convenience

The demand for barrier-free facilities in buildings is increasing, especially in privately owned homes and public buildings. Thresholds with a clearance height of 0 mm satisfy these requirements in every respect. The barrier-free solution by Gretsch-Unitas can be used with all GU-thermostep 164 and GU-thermostep 204 thresholds. It is system-compatible and identical in appearance to the solution for house entrance doors and balcony-doors. As far as the fabricator is concerned, everything from production through to installation in the project remains the same, the components that provide barrier-free passage are simply added.



Lift&Slide element (PVC) with GU-thermostep, barrier-free



Lift&Slide element (timber) with GU-thermostep, barrier-free

#### Good to know:

- Barrier-free Lift&Slide elements can be provided
- The existing threshold designs remain unchanged
- The threshold-to-structure connection remains unchanged
- As far as the fabricator is concerned, everything from production through to installation in the building remains the same
- The accessibility is provided by additional components
- Simple and easy installation

#### Benefits for user:

- Lift&Slide door with barrier-free passage
- Low maintenance and care due to removable profiles
- Visually appealing design
- Drainage type freely selectable
- Can be easily retrofitted to existing elements with GU-thermostep



## 7 Pre-assembled GU-thermostep threshold for Lift&Slide elements

### Made to measure for on-the-spot installation

With the GU-thermostep 164 and 204 thresholds, a fully made-to-measure, predrilled and pre-assembled solution can be ordered. The thresholds can be easily and safely installed on the spot. This service reduces the manufacturing time and manufacturing overheads, and therefore also the fabrication costs.

Two variants are available for prefabrication.

#### 1. Premium: high degree of prefabrication

The scope of delivery includes the threshold and all necessary accessory parts, cut to the required length, mounted and fixed with screws. The corner connectors are mounted and all required sealing work is done.

#### 2. Exclusive: high degree of prefabrication

The following hardware articles can be ordered made to measure:

- Drip rail extensions (25, 40, 60 mm)
- Vertical profile extensions
- Lift&Slide gears BS 27,5 BS 37,5
- The bogies are pre-assembled together with the connecting rod which has been cropped to the required length
- Guide track P 1786 and P 1850 made to measure incl. accessories for timber profile systems
- Structural connection set
- HS CleanUnit for cleaning roller track and reducing possible contamination of the rollers
- Comfort package with HS LiftUnit and handle damper as Light version for sash weights up to 350 kg and Heavy version for sash weights up to 600 kg
- Optionally available with DIRIGENT turn handle and security package for burglar inhibition according to RC 2

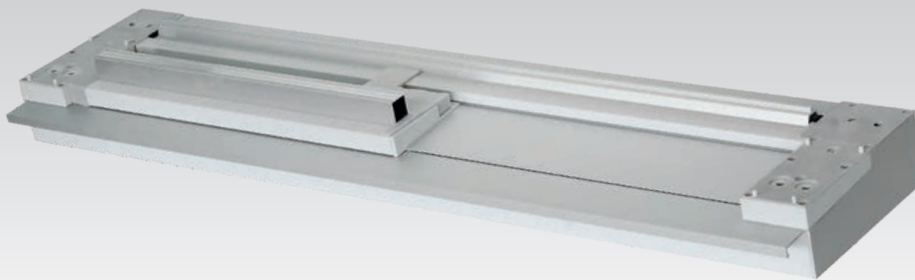

Threshold assembled to the highest degree of prefabrication

#### Good to know:

- No stock keeping of individual parts, so reduced inventory size and warehouse costs
- No offcuts and leftover amounts
- Reduced manufacturing time and costs
- Reduction of errors when cutting to size and also when calculating and ordering the threshold
- Simplified installation

#### Benefits for user:

- System threshold manufactured in outstanding quality to a high degree of precision
- Made in accordance with the CE certification



## 8 Structural connection for GU-thermostep thresholds

### Professional sealing as a one-stop service

The components that make up the GU-thermostep threshold, profile extension and installation kit have been tested and perfectly harmonised to produce a complete system. Gretsch-Unitas is therefore not only satisfying all energy saving criteria defined in the relevant regulations, but is also responding to the demand for an exceptionally high standard of living comfort. In this case which drip rail is used with the GU-thermostep 204 is irrelevant; the external extension profile is always flush with the outer surface of the drip rail because of the clip spring on one side. The GU installation set has also been tested as a system by ift Rosenheim GmbH and the advantages it provides due to ease of assembly and tightness have been demonstrated many times over.

### Application areas

- Sealing of Lift&Slide doors and windows against components in contact with the ground, such as cellar walls and ground slabs
- Sealing against ground moisture (capillary water, retained water) and non-accumulating seepage water (based on DIN 18195 Part 4)
- Sealing of balconies and patios in the outdoor areas

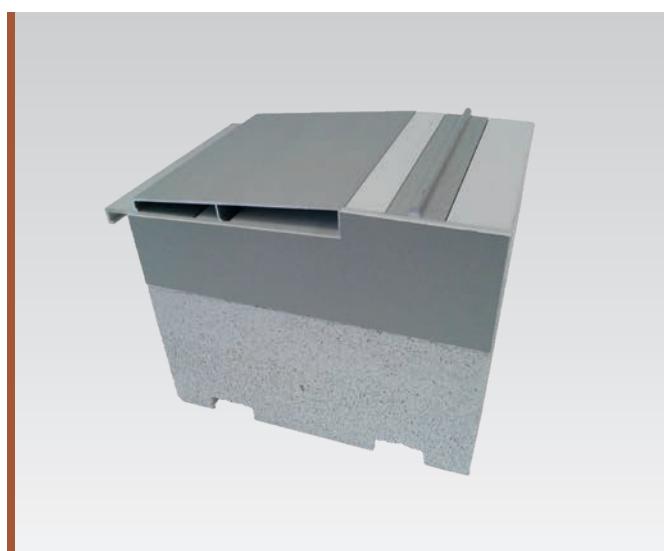

Profile extension for GU-thermostep – mounted flush with the threshold on the inside and outside, which ensures an optimum structural connection. Cover caps are fitted on the sides of the threshold to prevent ingress of moisture.

### Good to know:

- GU installation set: a system tested by ift Rosenheim GmbH
- Profile extension is very light, no steel reinforcement is required
- Easy and quick processing with already existing machines and tools

### Benefits for user:

- High degree of thermal insulation – approved for use in passive houses
- Prevents formation of condensate and mould
- Optimum structural connection
- High level of sound insulation

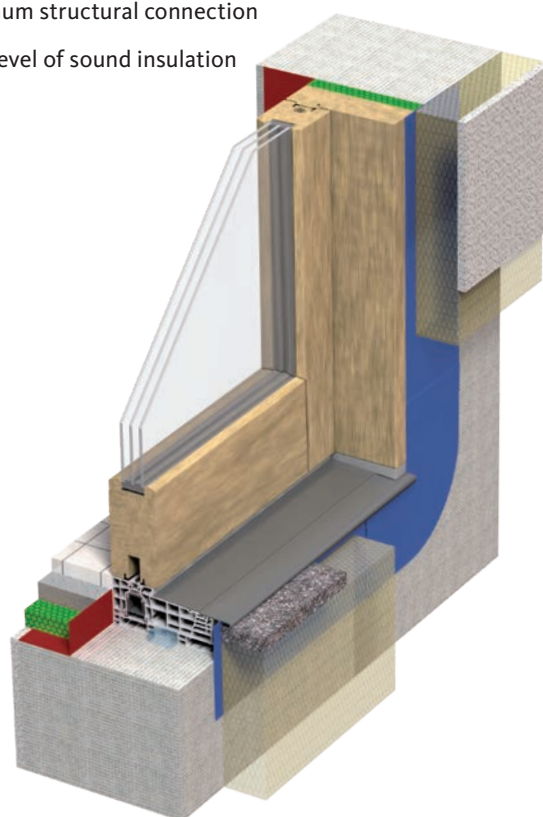

A professional seal using the approved GU installation set for Lift&Slide elements achieves an optimum result in combination with the the external, central and internal sealing levels.

# COMFORT

## MAXIMISED



As inventor and leading specialist partner for Lift&Slide hardware, Gretsche-Unitas has built a formidable reputation as provider of technically optimised solutions, many of which are unique on the market. The expertise and innovative technical prowess of Gretsche-Unitas has a proven track record in effectively responding to the increasing demands in relation to user friendliness of Lift&Slide systems.

Lift&Slide elements are exceptionally easy to access and use in combination with Gretsche-Unitas hardware. They are impressive because all parts are perfectly harmonised which ensures via the interaction of all components smooth operation and unparalleled comfort for users and door/window fabricators. Barrier-free versions are of course also available.

### ACCESS COMFORT

1 Makes light work of lifting heavy sashes  
**HS LiftUnit**

2 Universal threshold solution for added convenience  
**Barrier-free threshold**

Exclusively  
available only from  
Gretsche-Unitas

3 Elegant, comfortable and barrier-free  
**HS ePOWER motor-driven drive**

4 Added comfort which is easy to retrofit  
**HS Master motor-driven drive**

Exclusively  
available only from  
Gretsche-Unitas



## EASY OPERATION

- 5 For rebound-free, controlled lowering of the sash  
**Handle damper**
- 6 Reduces the operating force on the turn handle  
**Tension spring in Lift&Slide gear**
- 7 Tight controlled closing, also for light window sashes  
**Lowering safeguard**
- 8 Barrier-free in handle area  
**RONDO 400 mm extended handle**
- 9 Moving large elements with the greatest of ease  
**Lift&Slide bogie**



# Comfort maximised

GU

## 1 HS LiftUnit

Exclusively  
available only from  
Gretsch-Unitas

### Makes light work of lifting heavy sashes

The ever increasing size and weight of the glazing in Lift&Slide elements means that greater operating forces are required to move them – the handle torque increases noticeably and the Lift&Slide door becomes more difficult to operate. The HS LiftUnit supports the bogie when lifting the active sash. This reduces the torque at the handle by 50% which is accompanied by a noticeable increase in operating comfort for the user.

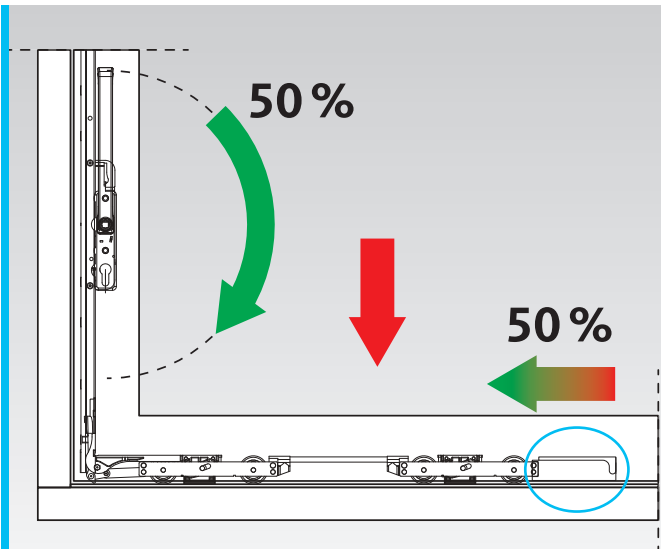
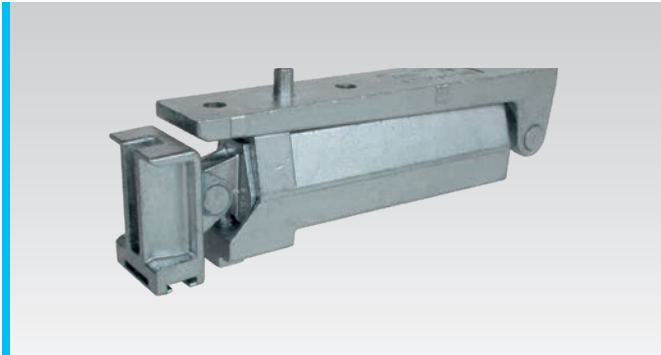

The operating force applied during opening and lifting of the Lift&Slide door is supported by the HS LiftUnit by 50%. Only half the operating force therefore needs to be applied at the handle. This makes operation significantly easier for the user, also with sashes weighing upwards of 200 kg.

### Good to know:

- Faster easier installation, thanks to pre-mounted components
- Suitable for all sash patterns
- For sash weights up to 600 kg
- **Ease of assembly:** the HS LiftUnit is used in combination with the GU-934 bogie. Changes to the bogie groove or leaf geometry are not required – production remains the same.
- Maintenance-free component

### Benefits for user:

- Up to 50% reduction in operating force when lifting the window sash
- Concealed installation – the HS LiftUnit is concealed in the sash frame
- No change to operation of the Lifts&Slide door
- **Simple retrofitting during renovations**  
If the glass panes need to be replaced during a renovation project, causing the element weight to increase, retrofitting an HS LiftUnit is not only recommended, it is also very easy to do.

### OUR RECOMMENDATION:

use the HS LiftUnit in combination with the handle damper to prevent the handle from rebounding when lowering the sash shortly before reaching the end position.

## 2 Barrier-free threshold



### Universal threshold solution for added convenience

The demand for barrier-free facilities in buildings is increasing, especially in privately owned homes and public buildings. Thresholds with a clearance height of 0 mm satisfy these requirements in every respect. The barrier-free solution by Gretsch-Unitas can be used with all GU-thermostep 164 and GU-thermostep 204 thresholds. It is system-compatible and identical in appearance to the solution for house entrance doors and balcony-doors. As far as the fabricator is concerned, everything from production through to installation in the project remains the same, the components that provide barrier-free passage are simply added.



Lift&Slide element (PVC) with GU-thermostep, barrier-free



Lift&Slide element (timber) with GU-thermostep, barrier-free

#### Good to know:

- Barrier-free Lift&Slide elements can be provided
- The existing threshold designs remain unchanged
- The threshold-to-structure connection remains unchanged
- As far as the fabricator is concerned, everything from production through to installation in the building remains the same
- The accessibility is provided by additional components
- Simple and easy installation

#### Benefits for user:

- Lift&Slide door with barrier-free passage
- Low maintenance and care due to removable profiles
- Visually appealing design
- Drainage type freely selectable
- Can be easily retrofitted to existing elements with GU-thermostep

You can find information on the topic of thresholds in the chapter BASICS on pages 10–13



## Comfort maximised

**GU**

### 3 HS ePOWER motor-driven drive

Exclusively  
available only from  
Gretsch-Unitas



#### Elegant, comfortable and barrier-free

Builders with high expectations put large-format Lift&Slide doors right at the top of their architectural wish list. Sash weights greater than 300 kg are not unusual, which makes Lift&Slide doors more difficult to open and close manually. The new one-stop solution HS ePOWER – an intelligent combination of tried-and-tested GU standard hardware, motor-driven drive and barrier free threshold – makes comfortable and safe operation possible and excludes tripping hazards. The Lift&Slide door is completely barrier-free according to DIN 18040.



All HS ePOWER components are concealed in the Lift&Slide sash. The three keypads of the manual control element with self-explanatory symbols can be operated intuitively.

#### Good to know:

- Pre-assembled, plug-in modules allow the assembly to be carried out quickly, easily and safely according to the plug-and-play principle and the door can be commissioned immediately
- Current transmission without cables via tappet contacts from frame to sash
- A cable connection between the frame and Lift&Slide door is not required because power is supplied by batteries concealed in the Lift&Slide door
- Installed on sash in exactly the same way as a Lift&Slide door without drive
- Unique in the Lift&Slide market

#### Benefits for user:

- Fully concealed components to meet design/aesthetic requirements
- Very easy to use due to motor-driven opening and closing
- Intuitive operation via three key panels at the operating element, also via optional handheld radio transmitter
- Thanks to integrated batteries, a cable connection between the Lift&Slide door and frame is not required
- Can be integrated into a smart home system
- Barrier-free according to DIN 18040 with GU-thermostep 204 and barrier-free threshold design in the passage area

## 4 HS-Master motor-driven drive



### Added comfort which is easy to retrofit

Tried-and-tested Lift&Slide hardware combined with modern drive technology – the HS-Master meets expectations for comfortable living and offers solutions for "barrier-free construction" in compliance with DIN 18040 using timber, PVC and metal elements. With the proven HS Master technology, all sash movements (lifting, sliding to the desired opening width, closing) are motor-driven and the sash is free of current and cables. The HS Master drive features a standard limit switch and is tested by DEKRA. Outstanding safety technology guarantees safe operation. Further optional safety devices can of course also be retrofitted with the HS-Master.

### Recommended for use in

hospitals, retirement and care homes, facilities for disabled persons and kindergartens.

### The system is operated by

- Wall switch/key switch
- Handle as impulse transmitter
- Radio remote control
- Push & Go
- Turn handle, e.g. in the event of a power failure

Can easily be retrofitted to existing GU-934 Lift&Slide doors.



HS Master, pattern A



HS Master, pattern C

### Good to know:

- Can be installed and used on all timber/plastic/metal profiles
- Fast reliable installation
- Supplied with integral plug
- Simple retrofitting

### Good to know:

- Can be easily retrofitted to existing elements
- With remote control
- Push-and-Go function
- Emergency operation via handles in the event of power failure
- Crush protection using safety technology
- No additional safety equipment required due to power cut-off



## 5 Handle damper

### For rebound-free, controlled lowering of the sash

The use of the handle damper in the Lift&Slide gear improves operating safety, particularly with large and heavy elements. Furthermore it provides controlled rebound-free sash-lowering as well as a controlled rotational movement of the handle.

Installation of a handle damper is recommended for Lift&Slide gears operating with sash weights of 100 kg or higher. It can also be retrofitted quickly and easily to every standard gear. It can of course also be used in combination with Gretsch-Unitas tension springs.

For optimum ease of use, the handle damper can be combined with the HS LiftUnit, which supports the bogie when lifting the active sash. This reduces the torque at the handle by 50%, which noticeably increases ease of use.



### Good to know:

- Can be used in every Lift&Slide gear

### Benefits for user:

- Ensures rebound-free controlled rotational movement of the turn handle
- The handle damper can also be retrofitted quickly and easily in every Lift&Slide gear

## 6 Tension spring in Lift&Slide gear

### Reduces the operating force at the turn handle

Using tension springs in the Lift&Slide gear lock reduces the operating force needed by the user at the turn handle, which greatly increases ease of use. The Lift&Slide door can be operated effortlessly as a result, especially with high sash weights up to 400 kg. If, for example, the door weight increases due to new glazing during a renovation, the operational forces also increase at the turn handle. The tension spring compensates for this increased force. Retrofitted installation of the tension spring is also possible at any time in every Lift&Slide gear version and is normally recommended starting at door weights above 200 kg.

### NOTE:

The tension spring is an alternative to the HS LiftUnit. The reduction in operating force is significantly higher with the HS LiftUnit.

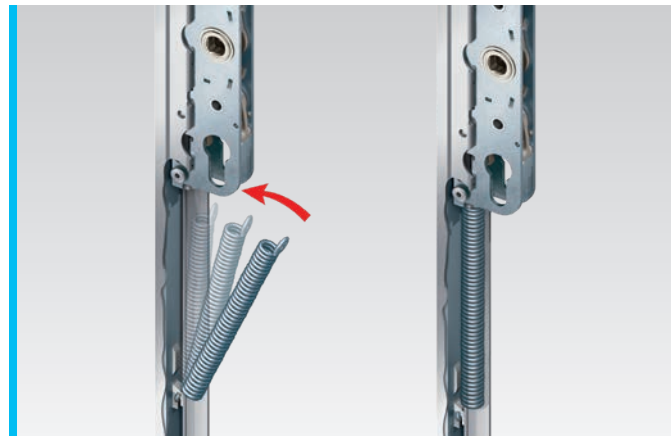

### Good to know:

- Can be retrofitted to every gear version of a Lift&Slide element
- Can be combined with handle damper

### Benefits for user:

- Force required when opening noticeably reduced (by 10%)
- Retrofittable at any time



## 7 Lowering safeguard

### Tight controlled closing, also for light window sashes

Light Lift&Slide elements are also possible due to innovative materials. Owing to their weight, these kinds of lightweight sliding sashes may not apply sufficient pressure to the horizontal gaskets at the bottom when lowered.

The lowering safeguard therefore presses the sliding sash downwards in a controlled fashion on to the threshold thus providing the required gasket pressure to ensure the desired tightness of the sliding sash.

The lowering safeguard can be used in combination with all the Lift&Slide gears.



#### Good to know:

- Can be used in combination with every GU gear
- Can be used in all timber/PVC/metal product versions
- Same tightness as large heavy sashes due to lowering safeguard
- Simple and easy installation

#### Benefits for user:

- Small light sashes also close securely and tight
- The Lifts&Slide door is operated in the usual manner

## 8 Extended handle – RONDO series – interior turn handle with and without PC hole

### Barrier-free in handle area

The RONDO extended turn handle is 400 mm long, which allows the turn handle to be comfortably operated, e.g. from a sitting position. Thanks to the lever action, the operating force required by the user to turn the extended handle bar is roughly 50% LESS.

Using an extended turn handle in combination with the handle damper, which prevents the handle from turning back shortly before reaching the end position, is a convenient solution which allows the Lift&Slide door to be lifted effortlessly.

The RONDO extended handle is suitable for barrier-free construction according to DIN 18040.

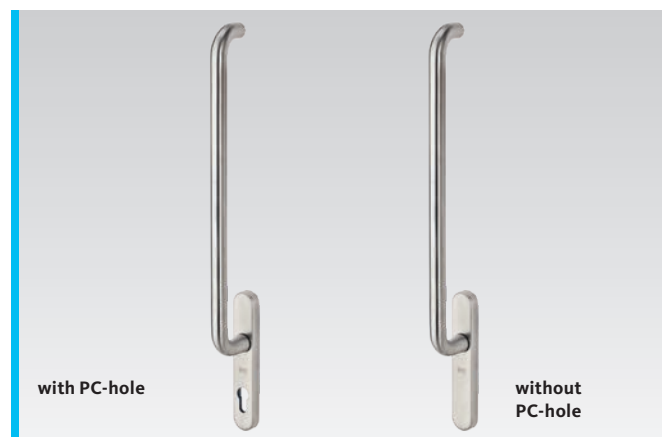

#### Good to know:

- Installation identical to standard handle
- Can be retrofitted quickly and easily

#### Benefits for user:

- Suitable for every element
- Can be used with all timber/PVC/metal profile materials
- The operating force applied during lifting is 50% less
- Can be retrofitted quickly and easily
- Can be integrated in master key systems when used with PC hole
- Material: stainless steel



## 9 Lift&Slide bogies

### Moving large elements with the greatest of ease

Gretsch-Unitas Lift&Slide bogies are convincing due to their well thought out design and outstanding product quality. They guarantee ease of operation and comfortable running smoothness throughout the whole application range. The bogie support which is integrated as standard into the bogie ensures uniform load distribution of the window sash when closed. Ball bearing-supported, plastic-coated rollers ensure outstanding running smoothness and ease of movement of the sliding sash.

### Good to know:

- The GU-934 bogies are used as standard with sash weights up to 350 kg and can be used with sash weights up to 600 kg in combination with the HS LiftUnit Heavy with tandem bogie
- The GU-937 bogies have an application range of up to 200 kg as the standard version and up to 400 kg as tandem bogie
- Outstanding manufacturing quality ensures durability in every application range
- Functional endurance tested with min. 25,000 cycles and max. sash weight

### Benefits for user:

- Satisfies the highest expectations in terms of comfort and running smoothness, also with large-format heavy elements
- Outstanding manufacturing quality ensures durability which is second to none
- Negligible operating forces in combination with the HS LiftUnit



**GU-934 Lift&Slide bogie with ferGUard\*silver finish**



**GU-937 Lift&Slide bogie with ferGUard\*silver finish**

# BURGLARY

## PROTECTED



Protection against burglary is one of the greatest challenges for Lift&Slide systems. After all, insufficiently secured windows and doors make it easy for unwelcome visitors to intrude into your home. It is therefore important also to equip Lift&Slide elements with security-relevant components.

Thanks to the burglar-inhibiting design of many of its hardware components, Gretsch-Unitas gives its customers greater peace of mind, because they know they are effectively protected against manipulation attempts.

All timber and PVC systems are tested at least to DIN EN 1627-1630 RC 2, and also up to RC 3 in timber. With Gretsch-Unitas, every element can essentially be designed to satisfy the stringent requirements of resistance class RC 3. We provide assistance with planning and design.

- 1 Open or locked, recognisable at a glance  
**Electronic locking monitoring with magnetic switch, VdS-tested**
- 2 Anti-jemmy device with a secure grip  
**L&S meeting-stile security profile**

- 3 A firm handle on security  
**DIRIGENT SK3 tested turn handle**
- 4 Anti-jemmy protection of sash  
**Anti-jemmy device top horizontal**





- 5 Open but still securely locked  
**Night ventilation for Lift&Slide doors**

**Exclusively**  
available only from  
Gretsch-Unitas

**NOTE:**

According to DIN 18104-2, all Lift&Slide hardware for timber and PVC systems by Gretsch-Unitas is certified for burglar-inhibiting retrofit products.



# Anti-burglary protection



## 1 Electronic locking monitoring with magnetic switch, VdS-tested

### Open or locked, recognisable at a glance

In addition to providing burglar protection by mechanical means, electronic monitoring can also be integrated into the Lift&Slide element at any time. With electronic locking monitoring via magnetic switch it is possible to see at a glance whether the Lift&Slide door is in the open position or locked. If the door is opened without authorisation, the magnetic switch is activated and the concealed contact forwards a signal to the control unit

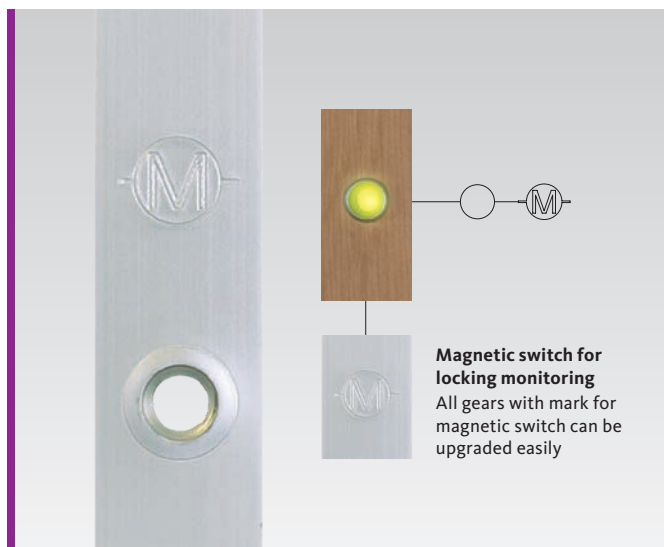

### Good to know:

- Can be installed in every Lift&Slide gear for pattern A, or can be mounted on every Lift&Slide element for pattern C unit
- Simple installation using pre-assembled components
- Lift&Slide gears with mark for magnetic switch can be upgraded easily

### Benefits for user:

- Know at a glance whether the door is open or securely locked

## 2 L&S meeting-stile security profile

### An anti-jemmy device with a secure grip

Burglar inhibition can be enhanced by using the L&S meeting-stile security profile in the meeting stile. Here, robust aluminium profiles with integrated gasket interlock over the full height of the sash to prevent it from being jemmied out. This ensures the highest possible level of security combined with tightness.

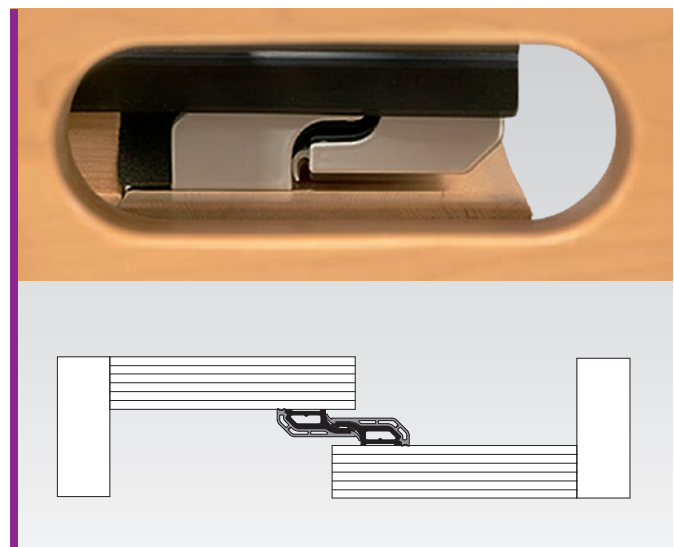

### Good to know:

- Preassembled component for straightforward fast installation
- Simply crop to the required sash height
- The L&S meeting-stile security profile comes with the necessary gaskets already integrated
- Available in various sizes for all standard sash distances

### Benefits for user:

- High degree of protection against jemmying out at meeting stile
- Maximum tightness between sash and fixed-glazed sash

### 3 DIRIGENT Lift&Slide turn handle PZ ZA SK3

Exclusively  
available only from  
Gretsch-Unitas

#### A firm handle on security

Lockable turn handles increase security and provide additional protection against burglary and manipulation attempts. If the turn handle is locked with a key the hardware mechanism is reliably blocked, the handle can therefore no longer be actuated and the active sash lifted and opened. A burglar can only open the Lift&Slide door by pushing in or smashing the glass, and not via the turn handle.

The DIRIGENT PZ ZA SK3 Lift&Slide turn handle is designed to receive a profile cylinder as standard. In combination with the locking cylinder, it offers outstanding security and a slim design. The security of the turn handle is further enhanced by integrated plug picking protection on the outside, which is fitted as standard. This provides additional protection for the locking cylinder on the outside.

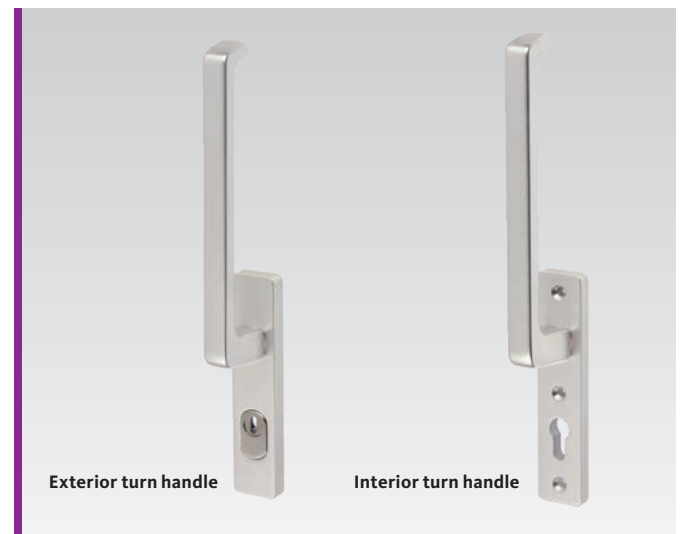

#### With proven high security standard:

SK3 = certified to EN 1906 in the burglar protection category protection classes 2 and 3 – and can therefore be used on RC 2 and RC 3 elements. With SKG\*\*\* certificate.

#### Good to know:

- Straightforward installation, in same way as every commercially available turn handle
- High-quality rugged handle made of solid aluminium

#### Benefits for user:

- For enhanced burglar protection
- With integrated plug picking protection on the outside as standard for even higher security
- SK3-tested and SKG\*\*\* certified, and therefore currently the most secure Lift&Slide turn handle on the market



## 4 Anti-jemmy device top horizontal

### Anti-jemmy protection of sash

The anti-jemmy device prevents the window sash from being jemmied out in the closed position. It ensures that the window sash cannot be lifted and tipped out of the frame.

Locking the door via the turn handle activates the anti-jemmy device and secures the element. Two locking levers now block the space between the sash and frame and therefore reliably prevent the sash from being jemmied out.



### Good to know:

- Suitable for all Lift&Slide elements
- Fast and straightforward installation, thanks to pre-assembled components

### Benefits for user:

- Reliably protects the window sash against being jemmied out
- Not visible due to concealed installation
- RC 2/RC 3-tested



## 5 Night ventilation for Lift&Slide doors

Exclusively  
available only from  
Gretsch-Unitas

### Open but still securely locked

In the past, the night ventilation position of a Lift&Slide element has always made it more vulnerable in terms of burglar resistance. With the night ventilation for Lift&Slide doors, Gretsch-Unitas has succeeded in creating an innovative solution, namely a system that reconciles two conflicting requirements.

With RC 2 tested Lift&Slide night ventilation, the sliding sash can be in the ventilation position and also provide effective burglar resistance as the sliding sash is locked securely to the frame in this position. The system only allows fresh air into the building, and keeps unwanted visitors out. Burglars therefore have no chance. Thanks to the integrated protective screen insects also stay outside.

The night vents for Lift&Slide doors consist of anodised aluminium profiles, and the integrated night ventilation frame cams are made of solid stainless steel. Optimally adapted filler pieces form a seal against the upper frame and downwards against the threshold.

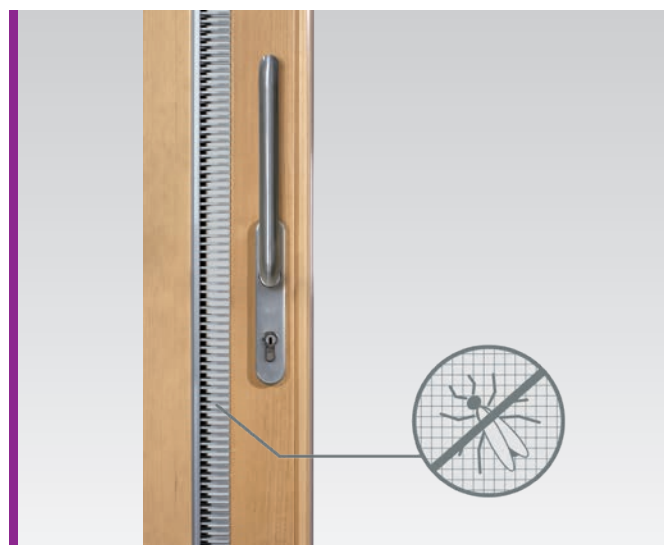

### Good to know:

- Fully pre-assembled module, easy installation
- RC 2 tested according to DIN EN 1627, also in ventilation position
- Optimum seal against upper frame and threshold with matching connectors
- Unique comfort and security offering for customers with high expectations

### Benefits for user:

- Outstanding ventilation convenience paired with high degree of burglar protection (RC 2 tested)
- Securely locked even in ventilation position
- Integrated into sash frame and therefore concealed when closed
- Simple operation
- Integrated insect screen

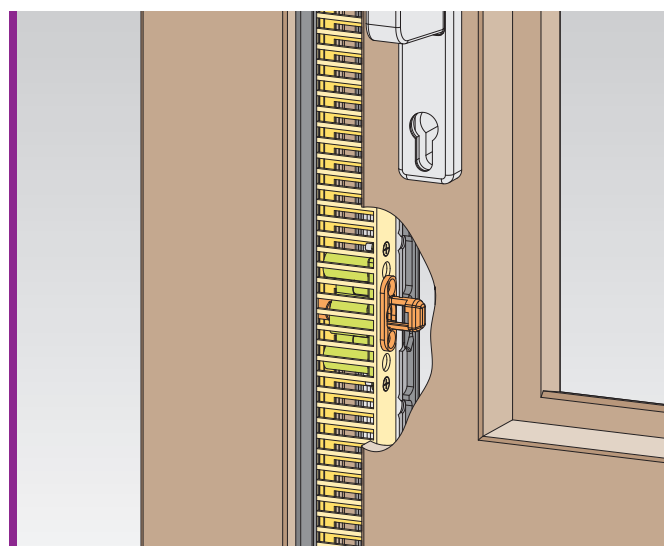

The 2-part frame cams also lock the sash securely in the ventilation position which protects the ventilated room against intruders; every frame cam is screwed securely into the steel plate

Recipient of **AWARD FOR INNOVATION IN ARCHITECTURE AND BUILDING** presented by the architecture journals AIT, ABIT and Intelligente Architektur, 2009

# OPERATION

## SAFED



In modern construction, the requirements in relation to functionality and operating reliability of Lift&Slide elements are becoming increasingly complex. The experience and technical expertise of Gretsch-Unitas gives it the leading edge which is proving successful in moving large and heavy Lift&Slide elements comfortably and safely.

A trend which is becoming more and more prevalent, not only in the private residential sector but also in commercial or public buildings, is the use of large-format Lift&Slide systems to maximise opening widths that are also subject to intensive use, often by different persons. As Lift&Slide sashes become increasingly heavier, the challenge is to ensure they can still be moved safely and easily, without causing injury to persons, or damage to the element or building structure.

1 Gentle braking operation  
**HS SilentClose**

2 Reliable stopping before end position  
**HS StopUnit**

3 A speed limit that makes sense  
**HS SpeedLimiter**

**Exclusively**  
available only from  
Gretsch-Unitas



4 For rebound-free lowering of the sash  
**Handle damper**

5 Buffered stop without damage  
**Puffer S**



## 1 HS SilentClose

### Gentle braking operation

The HS SilentClose damping unit gently brakes the Lift&Slide sash when opening or closing a few centimetres before reaching the end position then moves it automatically to the end position. The sash then only needs to be locked. This ensures outstanding ease of use, reduces the danger of entrapment and prevents impacts

between the sash and frame resulting in damage. The damping unit is installed fully concealed and is suitable for elements with sash weights up to 400 kg.

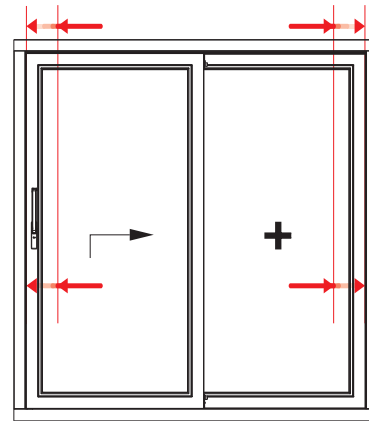

### Good to know:

- Simple and easy installation with no cutting or drilling templates required
- Pre-mounted components
- Suitable for all sash patterns
- For sash weights up to 200 kg and 400 kg
- The damping unit can be easily replaced simply by loosening a screw and without having to take off the Lift&Slide sash
- Can be used in the opening and/or closing direction

### Benefits for user:

- Concealed installation
- Outstanding operating convenience when opening and closing
- The Lifts&Slide door is operated in the usual manner
- Danger of entrapment is reduced as the sash closes slowly
- Protects the frame construction from impacts by the sliding panel

### PERFECT CO-PARTNERSHIP:

HS SilentClose and HS StopUnit can be installed on the same element. They can be combined in the open and closed position because the opening and closing operation for both products can be controlled separately.

The HS SilentClose and HS StopUnit damping units are not designed as safety components to protect people. They are designed to provide convenience and to protect the element.

## 2 HS StopUnit

### Reliable stopping before end position

The HS StopUnit damping unit stops the Lift&Slide sash a few centimetres short of the open or closed position to protect the element from damage due to the window sash striking against the frame. The window sash then needs to be pushed manually to the end position and locked. In contrast to HS SilentClose, more effort is not required to operate the sash manually. The HS StopUnit is recommended when using profile systems with

brush seals and in public buildings with changing users, e.g. hotel rooms. The damping unit is installed fully concealed and is available in two sizes, for sash weights up to 200 kg and 400 kg respectively.

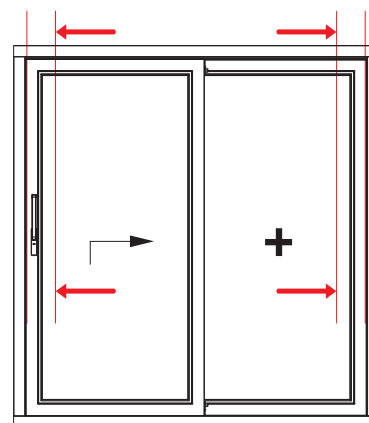

#### Good to know:

- Simple and easy installation with no cutting or drilling templates required
- Pre-mounted components
- Suitable for all customary sash arrangement patterns
- For sash weights up to 200 kg and 400 kg
- The damping unit can be easily replaced simply by loosening a screw and without having to take off the Lift&Slide sash
- Universally usable damping unit for all profile materials
- Can be used in the opening and/or closing direction

#### Benefits for user:

- Concealed installation
- Outstanding operating convenience when opening and closing
- The Lifts&Slide door is operated in the usual manner
- The operating force is not increased
- Danger of entrapment is reduced as the sash closes slowly
- Protects the frame construction from impacts by the sliding panel



### 3 HS SpeedLimiter

Exclusively  
available only from  
Gretsch-Unitas

#### A speed limit that makes sense

When a large and heavy Lift&Slide element is opened or closed, the sash gains momentum. As it accelerates, a build up of kinetic energy occurs which is then difficult to reduce.

The HS SpeedLimiter prevents uncontrolled acceleration of the sliding sash and restricts its speed to a maximum of 0.2 m/s. If the sliding panel moves faster than this it is stopped. Avoids injury to persons and damage to the building structure.

The HS SpeedLimiter is therefore particularly suitable for projects with more stringent safety requirements, all public facilities subject to accident prevention regulations (UVV in Germany) and all facilities for children such as kindergartens, primary schools, etc.



#### Good to know:

- Straightforward installation, thanks to pre-assembled component which only needs to be screwed on
- Retrofittable
- Outstanding operating reliability
- Unique in the Lift&Slide market

#### Benefits for user:

- Can be operated in the usual manner without restrictions
- Ideally suited for installation in public buildings, e.g. schools
- Avoids personal injury and damage to building structure

### 4 Handle damper

#### For rebound-free, controlled lowering of the sash

Using the handle damper in the Lift&Slide gear improves operating safety, particularly with large and heavy elements. Furthermore it ensures the sash is lowered in a controlled manner without rebound as well as controlled rotational movement of the turn handle.

Installation of a handle damper is recommended for Lift&Slide gears operating with sash weights of 100 kg or higher. It can also be retrofitted quickly and easily to every standard gear. Can of course also be used in combination with Gretsch-Unitas tension springs.

For optimum ease of use, the handle damper can be combined with the HS LiftUnit, which supports the bogie when lifting the active sash. This reduces the torque at the handle by up to 50%, which noticeably increases the ease of use for the user.



#### Good to know:

- Can be used in every Lift&Slide gear

#### Benefits for user:

- Ensures rebound-free controlled rotational movement of the turn handle
- The handle damper can also be retrofitted quickly and easily in every Lift&Slide gear

## 5 Buffer S

### Buffered stop without damage

**Rubber buffer S:** the conically-shaped rubber buffer brakes the sash when it is opened with a high momentum to avoid damage to the Lift&Slide sash and frame. Owing to its conical form, the buffer acts as a shock absorber. The kinetic energy is absorbed and cancelled out without transferring it to the surrounding masonry.

**Buffer S:** the buffer S is recommended for safe braking of the sliding sash in the opening direction and when using turn handles on both sides. It is positioned so that the sliding sash with the exterior handle cannot bump into the fixed-glazed sash. This avoids damage due to the window sash running into the handle and the frame element.

### Good to know:

- Silent soft braking of the sash
- Avoids damage to the frame element, provides the Lift&Slide sash with a cushioned stop

### Benefits for user:

- Stops the sliding panel softly and safely to avoid damage to the Lift&Slide element

### As buffer S in combination with the bracket:

- The buffer S is recommended for safe braking of the sliding sash in the opening direction and when using turn handles on both sides.

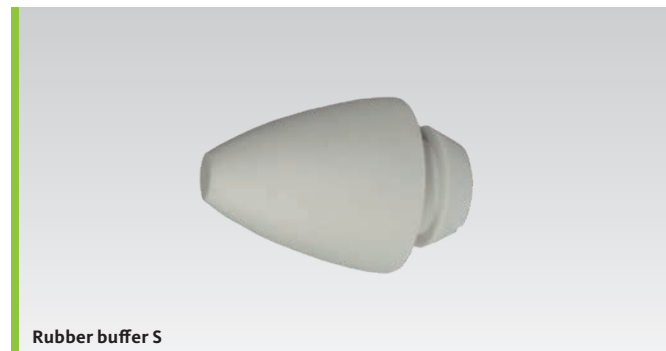

Pattern A (closed)

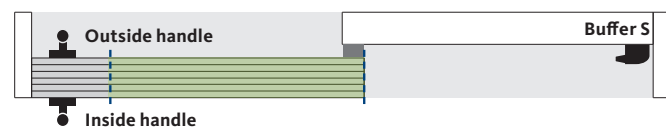

Pattern A (open)

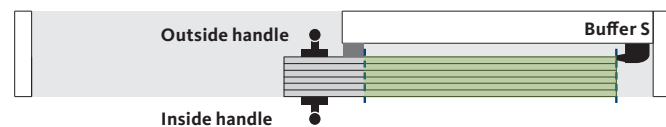

# VENTILATION

## OPTIMISED



Modern Lift&Slide elements are highly energy efficient and tight. Although this is good for the environment and reduces costs, it is more or less impossible to reconcile with the need for to exchange the exhaust air on the inside with the fresh air on the outside. This is why the most common ventilation method with Lift&Slide elements is still inrush airing, which is accompanied to some extent by a risk of burglary.

Night ventilation for Lift&Slide doors is an exclusive solution by Gretschi-Unitas that offers users and window/door fabricators high ventilation comfort and burglar protection rolled into one. The Lift&Slide door remains securely locked in the ventilation position. The system is tested to resistance class RC 2, which guarantees that customers with higher expectations receive an innovative security and comfort package.





1 Open but still securely locked  
**Night ventilation for Lift&Slide doors**

2 Effective secure night ventilation  
**Night vent frame cam and bottom keeper**

**EXCLUSIVELY FROM GRETSCH-UNITAS**

The system is also tested to RC 2 in the ventilation position and is therefore burglar resistant.

**Exclusively**  
 available only from  
 Gretsch-Unitas



## 1 Night ventilation for Lift&Slide doors

Exclusively  
available only from  
Gretsch-Unitas

### Open but still securely locked

In the past, the night ventilation position of a Lift&Slide element has always made it more vulnerable in terms of burglar resistance. With the night ventilation for Lift&Slide doors, Gretsch-Unitas has succeeded in creating an innovative solution, namely a system that reconciles two conflicting requirements.

With RC 2 tested Lift&Slide night ventilation, the sliding sash can be in the ventilation position and also provide effective burglar resistance as the sliding sash locked securely to the frame in this position. The system only allows fresh air into the building, and keeps unwanted visitors out. Burglars therefore have no chance. Thanks to the integrated protective screen insects also stay outside.

The night vents for Lift&Slide doors consist of anodised aluminium profiles, and the integrated night ventilation frame cams are made of solid stainless steel. Optimally adapted filler pieces form a seal against the upper frame and downwards against the threshold.

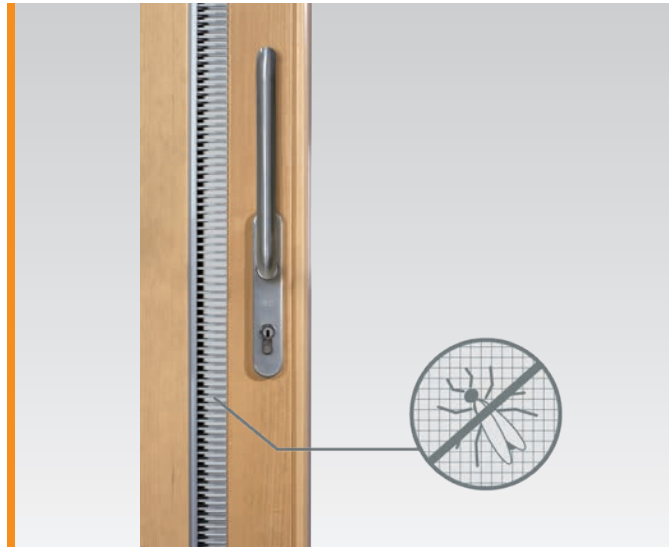

### Good to know:

- Fully pre-assembled module, easy installation
- RC 2 tested according to DIN EN 1627, also in ventilation position
- Optimum seal against upper frame and threshold with matching connectors
- Unique comfort and security offering for customers with high expectations

### Benefits for user:

- Outstanding ventilation convenience paired with high degree of burglar protection (RC 2 tested)
- Securely locked even in ventilation position
- Integrated into frame and therefore concealed when closed
- Simple operation
- Integrated insect screen

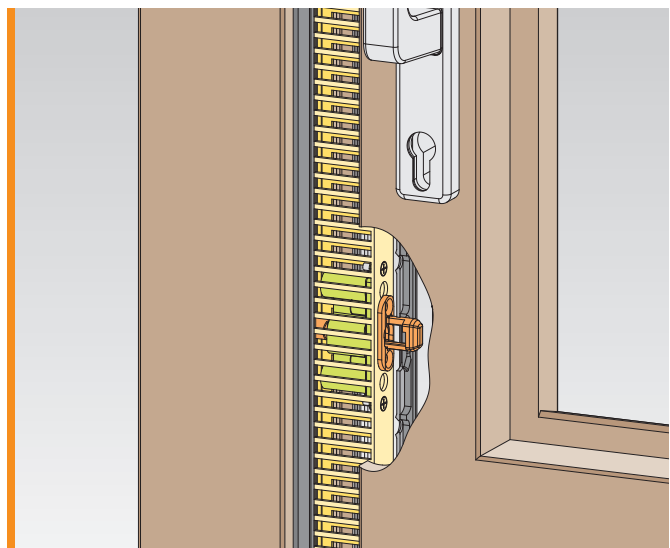

The 2-part frame cams also lock the sash securely in the ventilation position which protects the ventilated room against intruders; every frame cam is screwed securely into the steel plate

Recipient of **AWARD FOR INNOVATION IN ARCHITECTURE AND BUILDING** presented by the architecture journals AIT, ABIT and Intelligente Architektur, 2009

## 2 Night vent frame cam and bottom keeper

### Effective secure night ventilation

The classic version of the night ventilation for a Lift&Slide element is based on a combination of night ventilation frame cams and matching bottom keeper. The recess in the bolt and bottom keeper of the Lift&Slide door provides an additional night ventilation position and also a locking device for the locking rod in the bottom frame element. The lateral locking in the frame is retained. The result is a secure additional opening position of 10 mm.

### Good to know:

- Fast and easy to install due to pre-assembled components
- Can be used in pattern A, D, H, F, G2, G3 and K

### Benefits for user:

- Air exchange can also take place when the building is unoccupied
- Retrofittable

### NOTE:

The manufacturer does not recommend using the classic method of night ventilation as it does not offer reliable protection against manipulation attempts in the ventilation position.

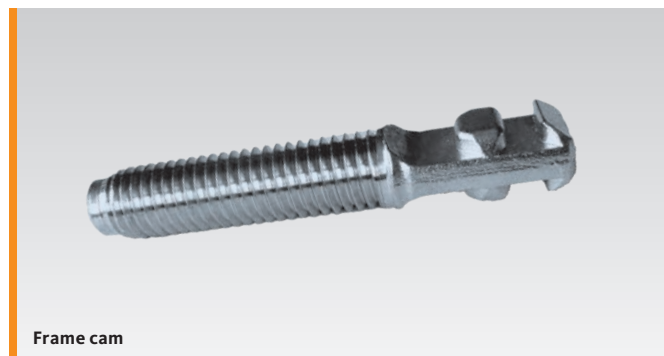

Frame cam

For an additional night ventilation position of 10 mm with locking on the door frame

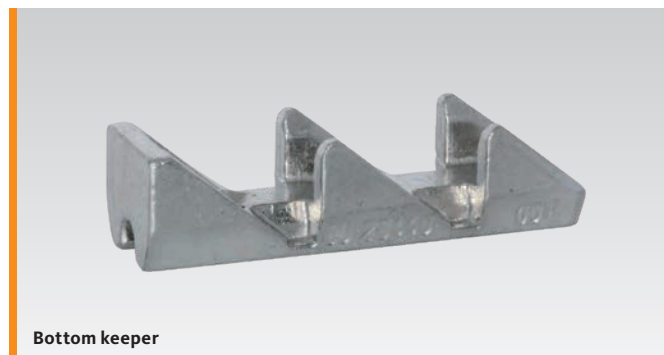

Bottom keeper

Enables the locking rod to be located in position in the bottom frame element.

# DESIGN

# HONED TO PERFECTION



Large-format glass frontages have a decisive impact on the architectural design of modern buildings. They must inspire and enthuse both functionally and aesthetically.

Complex technical solutions are required to meet the increasing demands in relation to the security and comfort of Lift&Slide doors. The expectations in relation to the aesthetic quality of buildings that provide an environment that is highly conducive to living and working are however also increasing. As far as Gretsch-Unitas is concerned, perfect functionality always goes hand in hand with aesthetic design that can be adapted to the required ambience in each case.

The right sash configuration for every room design – up to a total width of 20 metres.

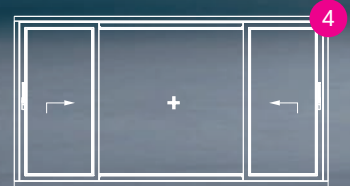

- 1 Maximum glazing to maximise sense of space  
**GU panoramic glazing**
- 2 Moving as if by magic  
**Concealed top guide track**

- 3 Comfortable operation and visually appealing design  
**Turn handles**
- 4 Versatile and multi-faceted  
**Patterns A–L**



- 5 Corner elegance  
**Lift&Slide element for 90° corner**
- 6 Elegant, comfortable and barrier-free  
**HS ePOWER motor-driven drive**

**Exclusively**  
available only from  
Gretsch-Unitas



## 1 Lift&Slide element with panoramic glazing

### Maximum glazing to maximise sense of space

Increasingly larger window areas are architecturally in vogue. This brings more daylight into living spaces and blurs the boundaries between inside and outside. The GU-thermostep for Lift&Slide elements with panoramic glazing meets the highest demands in terms of design and living convenience by maximising the glazing area in the fixed panel section. The technical overall concept of Gretsch-Unitas for the panoramic glazing with Lift&Slide elements in the fixed panel is setting new standards on the market:

- The fixed panel is mounted directly on the threshold using an adapter profile. Aluminium facings hold the glass securely in position
- This construction allows glazing subsequently to be easily inserted into the fixed panel
- The continuous structural connection is on the same plane as the side frames and the threshold. This provides the advantages of a continuous sealing plane and planning certainty during installation, as water drains off above the water-carrying level

### Good to know:

- **Same structural connection and floor construction:** in terms of planning and execution, the bottom structural connection and floor construction are identical to the standard Lift&Slide doors with GU-thermostep 204 threshold
- **Same components:** the GU-thermostep threshold and its structure extending to the fixed-glazed sash are fabricated with the same components as are standard Lift&Slide doors
- **Adapter profile with accessories:** an adapter profile with accessories is used instead of the standard attachment track
- **Cost savings:** production costs can be reduced due to omission of the fixed sash

### Benefits for user:

- Using fixed panels with floor-to-ceiling panoramic glazing maximises the sense of space and expansiveness
- Maximum glazing, no frame profile visible in fixed-glazed sash



The glass completely disappears into the frame

## 2 Concealed top guide track

### Moving as if by magic

The concealed top guide track maximises the field of vision in the upper part of the frame.

It is fully integrated in the frame element, supports the guides of the sliding panel and ensures, independently of the weight of the sash, that the Lift&Slide door moves safely and easily.

When lowered, the Lift&Slide door is tightly closed and forms a narrow gap above the sash. When raised, there is sufficient clearance in relation to the door frame. The gaskets are no longer in contact with the guide track and the sash can be moved freely and easily.



### Good to know:

- No additional effort when manufacturing the frame (milling of groove)
- Design-oriented solution and alternative to visible face-fixed upper guide track
- Perfect solution for elements with panoramic glazing

### Benefits for user:

- Aesthetically pleasing solution



## 3 Turn handles

### Comfortable operation with appealing design

The uniform range of turn handles by Gretsch-Unitas makes coherent design of all handles in every part of the living environment possible, irrespective of whether they are for window or door elements. The functional endurance of all handles is tested as standard which ensures they last a lifetime.

The turn handles have a pleasant feel and move Lift&Slide elements weighing up to 600 kg. The handle connection guarantees that the handle moves virtually without play.

The two supporting cams on the rosette increase stability during use and ensure the handle is precisely mounted. A double spring bridge is introduced into the detent as standard.

The turn handles and flush pulls for Lift&Slide elements are available in various materials and finishes. Turn handles for actuation on both sides, versions for the Swiss round cylinder and many special versions round off the range of turn handles.

### Standard – wide range of versions with classic designs

A large number of versions from our DIRIGENT, RONDO and BELCANTO series are available for operation of Lift&Slide elements:



### Diversity in the agenda

The GU range of handles ensures a wide range of design options. The choice includes classic or modern design forms and special forms, high-quality hardware and handles made of aluminium, stainless steel or brass and also gloss or matt surfaces that are

resilient and easy to maintain. Different colours and special colours can be obtained using specific coating methods, to cater for individual colour concepts in the building for example.



Silver / EV 1 look



Solid brass



Matt stainless steel



**Good to know:**

- All handles are delivered pre-assembled

**Benefits for user:**

- Turn handles can be easily retrofitted or replaced at any time
- Wide range of designs and materials available

- Pleasant feel, comfortable operation

- All handles in every part of the living environment can be designed consistently (doors, windows, Lift&Slide element)

- Tested for long-term endurance

**Special shapes**

**Exclusively**  
available only from  
Gretsch-Unitas

**RONDO extended turn handle**



**DIRIGENT turn handle – Burglar inhibition**  
Tested in accordance with EN 1906 in classes 2 and 3 of the burglar protection category – can be used on RC 2 and RC 3 elements, SKG\*\*\*-certified – see page 27



**DIRIGENT turn handle – Removable, suitable for customer's own coating**

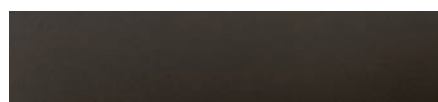

Dark brown (similar to RAL 8022)



White (RAL 9016)



## 4 Patterns A–L for systems up to 20 metres wide

### Versatile and multi-faceted

The illustration of patterns A to L provides an overview of the various sash configurations for Gretscht-Unitas Lift&Slide elements. The Lift&Slide range by Gretscht-Unitas provides many options to reflect current market demands. Owing to the large number of sash configuration options, many different

versions are possible which provides scope to plan and design for individual requirements. The entire range is of course CE-certified. Furthermore, all standard patterns are RC 2 tested without exception.

### Unlimited scope of possibilities

Gretscht-Unitas provides Lift&Slide solutions that fit precisely in every installation situation and are implemented entirely according to the wishes of the customer or architect. The illustration shows an overview of the most common patterns. Further variants and also customised special solutions are possible.

#### Pattern A

1 Lift&Slide door  
1 fixed-glazed sash  
Drawing: sliding to the right

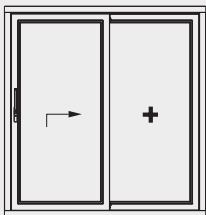

#### Pattern A3

1 Lift&Slide door  
1 fixed-glazed sash  
Drawing: sliding to the left

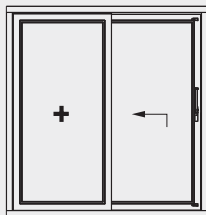

#### Pattern C

2 Lift&Slide doors  
2 fixed-glazed sashes  
Drawing: sliding to the right and left

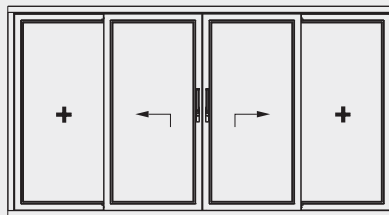

#### Pattern D

2 Lift&Slide doors  
Drawing: sliding to the right and left

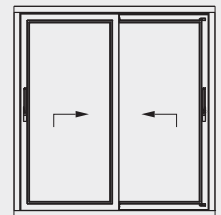

#### Pattern G2 asymmetrical with fixed mullion

1 Lift&Slide sash  
2 fixed-glazed sashes  
Drawing: sliding to the right

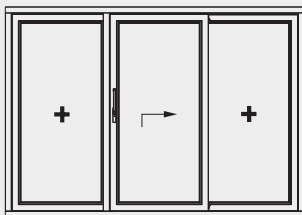

#### Pattern G3 asymmetrical without fixed mullion

1 Lift&Slide sash  
2 fixed-glazed sashes  
Drawing: sliding to the right

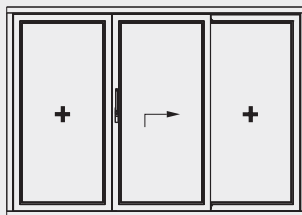

#### Pattern H

3 Lift&Slide sashes  
(same as pattern G1 symmetrical)  
Drawing: sliding to the right and left

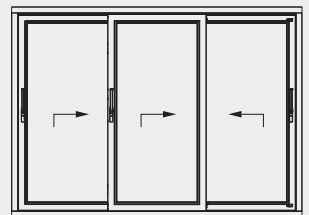

**Good to know:**

- Many different versions of patterns can be implemented
- Wide range of services for every customer requirement
- Lift&Slide elements with an overall width of up to 20 metres can be implemented

**Benefits for user:**

- The right pattern for every room design
- The sash configuration can be individually adapted to every living situation

**Pattern E**

2 Lift&Slide doors  
1 fixed-glazed sash  
Drawing: sliding to the right

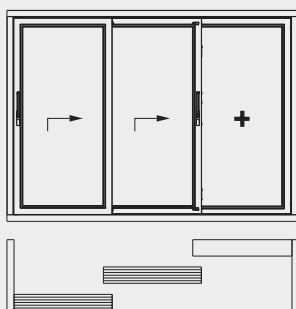

**Pattern F**

4 Lift&Slide doors  
Drawing: sliding to the right and left

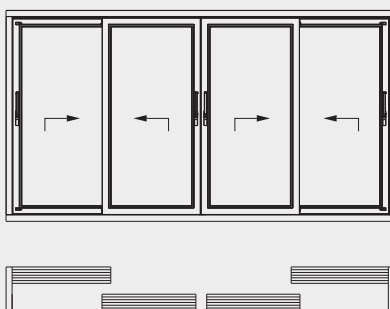

**Pattern G1 symmetrical**

1 Lift&Slide sash  
2 fixed-glazed sashes  
Drawing: sliding to the right

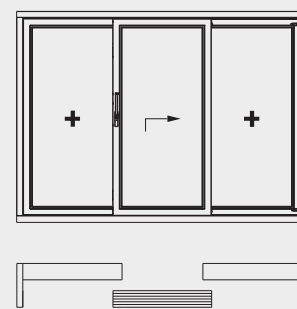

**Pattern K**

2 Lift&Slide doors  
1 fixed-glazed sash  
Drawing: sliding to the right and left

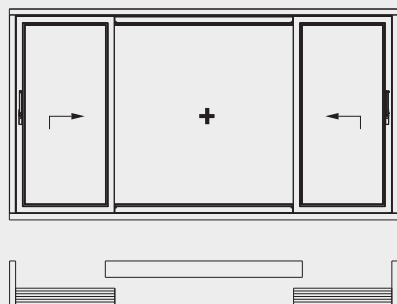

**Pattern L**

4 Lift&Slide doors  
2 fixed-glazed sashes  
Drawing: sliding to the right and left

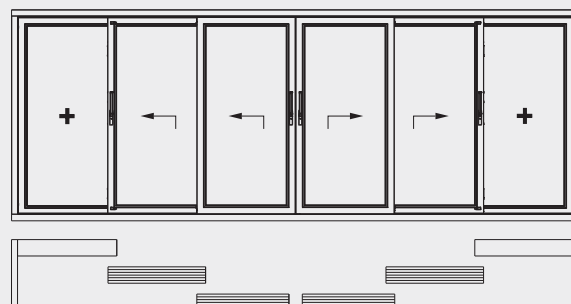



## 5 Lift&Slide element for 90° corner

### Corner elegance

Solutions for rectangular floor plans are among the highlights of the Lift&Slide special designs. They can create sophisticated architectural accents. The large glazing area opens up the corner of the building visually, light enters from both sides and extends the space. When the sliding sashes are open, the boundaries between the inside and outside are blurred, which creates a fascinating sense of space.

As a prerequisite, the structural design of the building must be adapted to this application. Gretsch-Unitas has the expertise and experience to provide flawless technology for this application. Thanks to the changed configuration of bogies and Lift&Slide gears, a collision of Lift&Slide handles near the corners of elements is eliminated. Both sashes are operated via the meeting stile. This solution can be implemented using standard components with no additional installation time/effort required. The roller track and guide track are mitred and run elegantly into the 90° corner.

### Good to know:

- Design-oriented comfortable and technically sound solution
- Only for use with standard hardware
- No additional time/effort required to install hardware
- Can be applied to all conventional timber systems

### Benefits for user:

- An architecturally innovative ambience can be created according to individual requirements
- Maximum opening width in the 90° corner
- Transparency with generous lighting and visibility conditions



Lift&Slide element for 90° corner

## 6 HS ePOWER motor-driven drive



### Elegant, comfortable and barrier-free

Builders with high expectations put large-format Lift&Slide doors right at the top of their architectural wish list. Sash weights greater than 300 kg are not unusual, which makes Lift&Slide doors more difficult to open and close manually. The new one-stop solution HS ePOWER – an intelligent combination of tried-and-tested GU standard hardware, motor-driven drive and barrier free threshold – makes comfortable and safe operation possible and excludes tripping hazards. The Lift&Slide door is completely barrier-free according to DIN 18040.

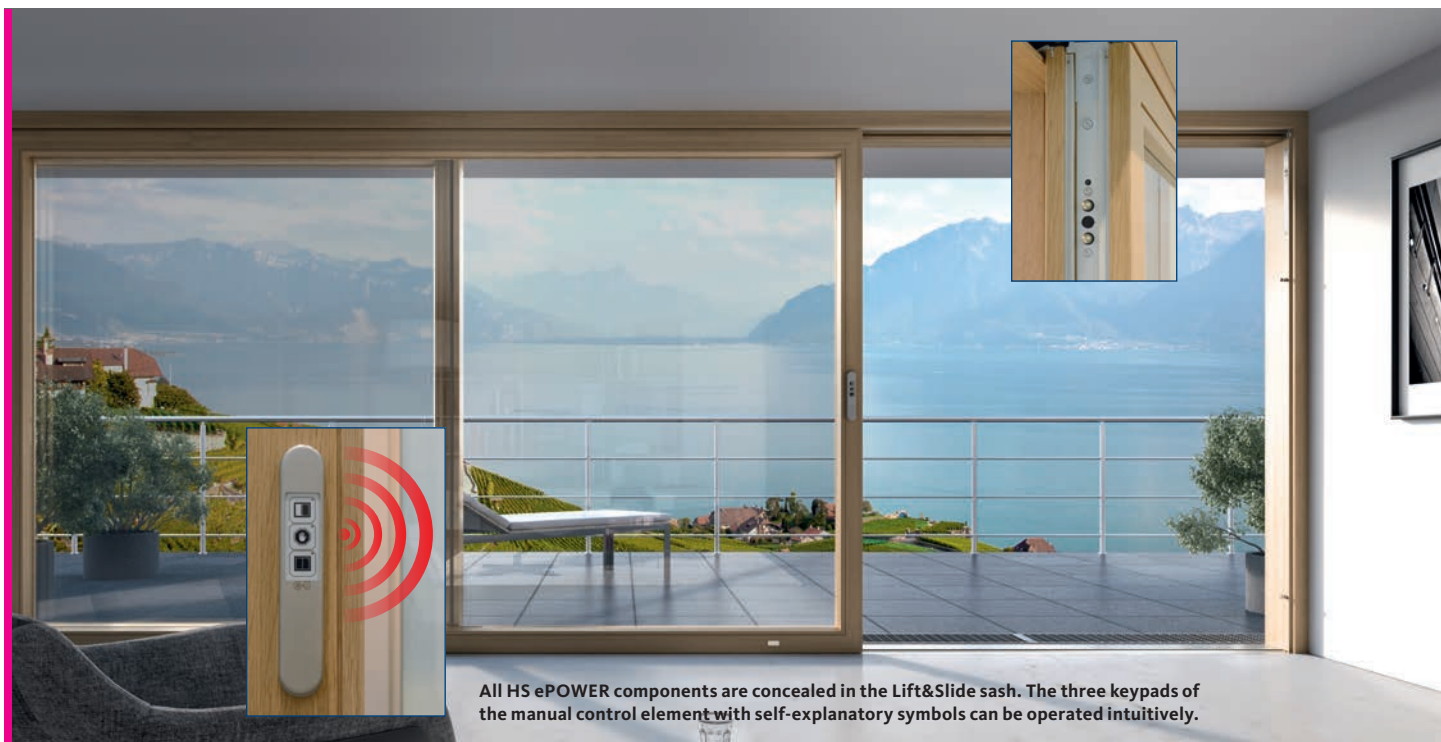

All HS ePOWER components are concealed in the Lift&Slide sash. The three keypads of the manual control element with self-explanatory symbols can be operated intuitively.

#### Good to know:

- Pre-assembled, plug-in modules allow the assembly to be carried out quickly, easily and safely according to the plug-and-play principle and the door can be commissioned immediately
- Current transmission without cables via tappet contacts from frame to sash
- A cable connection between the frame and Lift&Slide door is not required because power is supplied by batteries concealed in the Lift&Slide door
- Installed on sash in exactly the same way as a Lift&Slide door without drive
- Unique in the Lift&Slide market

#### Benefits for user:

- Fully concealed components to meet design/aesthetic requirements
- Very easy to use due to motor-driven opening and closing
- Intuitive operation via three key panels at the operating element, also via optional handheld radio transmitter
- Thanks to integrated batteries, a cable connection between the Lift&Slide door and frame is not required
- Can be integrated into a smart home system
- Barrier-free according to DIN 18040 with GU-thermostep 204 and barrier-free threshold design in the passage area

# SERVICE ENHANCED



All from a single source: in addition to the product and advice, Gretsched-Unitas also provides many services tailored to individual customer requirements.

Subsequent installation and commissioning by specialists ensures compliance with the standards and guarantees the safety of the users. Once the product is installed, regular maintenance ensures that the Lift&Slide product retains its value and functional reliability throughout its entire lifetime. And if anything does go wrong, a comprehensive network of customer service fitters will soon provide the remedy.



The basis for successful construction projects  
**Planning support**



Comprehensive and technically up-to-date  
**Tender-Text-Manager**



The right products in the right quantity  
**configUurator**



Provision of hardware data  
**Hardware data service**



For straightforward planning  
**Free download**



Information at the click of a mouse  
**Customer Information System**



Maximum security as standard  
**Licences and CE**



First-hand practical knowledge  
**Seminars and training courses**



Fewer costs and legal peace of mind  
**In-house test centre**



On-site service  
**Technical field staff**



All you need for perfect planning  
**Hotline for architects**



Service and maintenance  
**GU Automatic GmbH**



### PLANNING SUPPORT

The basis for successful construction projects

GU group provides comprehensive support in the planning phase. In close collaboration with the customer, comprehensive cross-trade concepts tailored to the individual building requirements are developed. These take into account the **safety of the building and occupants** and **barrier-free freedom comfort and aesthetics** in equal measure.



### TENDER-TEXT-MANAGER

Comprehensive and technically up-to-date

Comprehensive and technically up-to-date: with the Tender-Text-Manager, the GU group is offering architects and planners a convenient online tool that allows them to effortlessly compile tender specifications; existing tenders can be uploaded to the Tender-Text-Manager and processed via an integrated import function.



### CONFIGURATOR

The right products in the right quantity

The practical confiGurator is an online platform where **part lists and hardware sets can be precisely determined**. Based on the specifications for the particular project, a technically correct part list is generated within seconds. The data is determined based on current conditions and fundamental technical principles.





## HARDWARE DATA SERVICE

Provision of hardware data



## FREE DOWNLOAD

For straightforward planning



## CUSTOMER INFORMATION SYSTEM

Information at the click of a mouse

GU group supplies **individual database files for fenestration programmes** according to customer requirements within the framework of the project. The database files are **generated according to our order catalogues or in compliance with the fabricator's individual request**. Consequently, the customer receives project-related data **with commercial and technical details** for the "Fenestration programmes and software from the window and door industry".

Information on the products and applications is available to download from the company website to the local hard disc quickly, conveniently and free of charge: from **product documents and installation drawings** to **Declarations of Performance** through to **software solutions**.

The Customer Information System (CIS) is an **ordering and information system for all GU group products**. Customers can use the online platform 24 hours a day 7 days a week to access important information: from **preparing a quotation** through to performing an **availability check** in real time, from **placing the order** to **tracking the order**.



### LICENCES AND CE

Maximum security as standard



### SEMINARS AND TRAINING COURSES

First-hand practical knowledge



### RC 2/RC 3 SYSTEM TESTING FOR TIMBER

Successfully tested RC approval for our customers

As **system provider** for windows and balcony-doors, GU group provides the service of **transferring the right to you to use our test results**. This Cascading ITT procedure enables you to CE mark your timber windows and balcony-doors in accordance with the **EN 14351-1 product standard** without having to carry out your own tests.

Gretsch-Unitas assists the specialist companies with the implementation of their Factory Production Control (FPC), CE marking and Declaration of Performance. **A license can also be acquired.**

This licence contains the system folder "CE marking for windows and balcony-doors made of timber", including test reports and calculation tools, to help you manufacture window systems (and make the relevant declarations) in accordance with the **EN 14351-1 product standard**.

With a large number of events annually, GU group offers an extremely wide range of seminars and training courses. **The programme includes the following events in the area of Lift&Slide elements:**

**Expertise for burglar inhibition:** specialist seminars with RC 1N, RC 2N and RC 2 licensing for burglar-inhibiting windows and balcony-doors using GU group products with the following objective:

- Authorisation of the participants
- Licensing of specialist companies

and the **advanced course Burglar-inhibiting retrofitting according to DIN 18104-2.**

The specialist seminar **The hardware world of manually and motor-driven sliding elements** provides you with the knowledge you need to design and move large-format Lift&Slide elements together with Gretsch-Unitas using the HS Master and HS ePOWER product solutions, among others.

All details and further seminars are provided at: **www.g-u.com**

Gretsch-Unitas is offering its customers the opportunity to use test documentations, without having to carry out the tests themselves providing they attend a training course and subsequently conclude a **license agreement**.

With the system file "**Burglar-inhibiting windows and balcony-doors to EN 1627-1630**" specialist companies can manufacture their window systems so they satisfy the requirements for burglar-inhibiting components.



## IN-HOUSE TEST CENTRE

Fewer costs and legal peace of mind

Testing of elements in-house for and with customers offers system benefits for the fabricator: **reduced costs and legal peace of mind.**



## TECHNICAL FIELD STAFF

On-site service

**Specially trained** service engineers provide you with support **on-site** – from the planning stage through to commissioning and also by training users and **answering questions that arise during operation.**



## HOTLINE FOR ARCHITECTS

Hotline for detailed information and answers to questions

For any planning questions that may arise, or if detailed information on the GU group products is required:

The building project consultants at the hotline for architects provide one-to-one expert advice:  
by telephone **+49 2051/201-2000**, email **objektberatung@g-u.de** or can also be contacted using the **form** at the company website **www.g-u.com**



### Service and maintenance by GU Automatic GmbH

GU Automatic GmbH has its own fleet of vehicles and provides an extensive network of more than 70 service engineers all over Germany.

Short distances and fast response times combined with the in-house service hotline guarantee that our customers receive outstanding service round the clock.







## Exclusion of liability

The information provided in this publication consists of product descriptions. This is general information based on our experience and tests and therefore does not take any specific application into account. No claims for compensation can be made on the basis of the product descriptions.

Although we have made every attempt to ensure the information provided here is accurate, it is non-binding. It should be adapted to the respective construction projects, usage and specific on-site demands.

This publication has been compiled to the best of our knowledge. The Gretschi-Unitas group accepts no liability for any errors. The document is subject to modifications during the course of technical developments.

The product images shown in this publication may differ from the actual product.

## Publisher:

Gretschi-Unitas GmbH  
Baubeschläge  
Johann-Maus-Str. 3  
71254 Ditzingen, Germany  
Tel. + 49 (0) 71 56 3 01-0  
Fax + 49 (0) 71 56 3 01-2 93  
[www.g-u.com](http://www.g-u.com)

## Copyright notice

© All illustrations and texts in this publication are protected by copyright. Unless otherwise stated on the image, the rights belong to the Gretschi-Unitas group. Any use of copyright protected materials without the consent of the holder of the rights is prohibited.





FENSTERTECHNIK  
TÜRTECHNIK  
AUTOMATISCHE EINGANGSSYSTEME  
GEBÄUDEMANAGEMENTSYSTEME

Gretsch-Unitas GmbH  
Baubeschläge  
Johann-Maus-Str. 3  
D-71254 Ditzingen  
Tel. +49 7156 301-0  
Fax +49 7156 301-77980

GU Automatic GmbH  
Karl-Schiller-Straße 12  
D-33397 Rietberg  
Tel. +49 5244 9075-100  
Fax +49 5244 9075-599

[www.g-u.com](http://www.g-u.com)

Securing technology for you

