

Molteni & C

OZ— NICOLA GALLIZIA 2011

1—
3



Oz is an item that is easily converted from “sofa” into a comfortable “bed.” The sofa has an adjustable back with two positions to create seats that offer different depth and comfort. The sofa is converted into a “bed” by the cutting edge patented mechanism that enables extraction of the bed base with depth 200 cm, and causes lateral armrests to automatically fold in under the frame. The completely removable fabric covering is characterised by quilted parts with an original design and coloured stitches that contrast with fabric hues. Oz can be enriched with additional cushions.

DATASHEET

REGISTERED
DESIGN

I.2015

molteni.it

Dimensions in millimeters and inches. The right to discontinue and make changes is reserved. This information is based on the latest product information available at the time of printing.

FINISHES

COVERS

fabric - leather, completely removable.

Oz can only be produced in the fabric range indicated in the combination table.

Available in fire-resistant version (TB117 and BS5852).

TECHNICAL INFORMATION

SOFA BED STRUCTURE

Painted steel with pivot movement and gas springs.

BACK AND ARMREST STRUCTURE

Frame made of solid fir (Picea abies) and chipboard.

STRUCTURE PADDING

High capacity variable density foam polyurethane. Light velvet cover.

FEET

Painted steel with plastic wheels on the front section.

MATTRESS/SEAT

Polyurethane of different densities and non-allergic polyester fibre. 100% cotton cover.

BACK CUSHIONS

Down and polyester-filled compartments. 100% cotton cover.

REMOVABLE OUTER COVERS

(See attached card, specific for each cover).

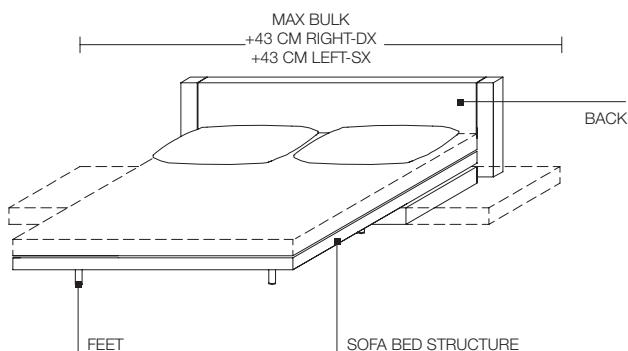
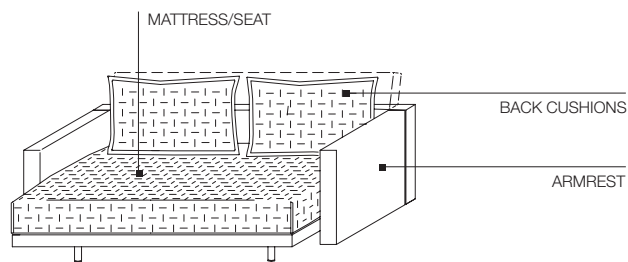

DATASHEET

REGISTERED
DESIGN

I.2015

DIMENSIONS

sofa-bed

sofa version W 1830 D 1150 H 670/900 W 72" D 45 1/4" H 26 3/8"/35 3/8"
bed version W 1830 D 2060 H 670 W 72" D 81 1/8" H 26 3/8"
mattress W 1600 D 2000 H 110 W 62" D 78 3/4" H 4 3/8"

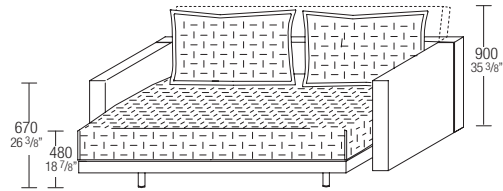

OD L180

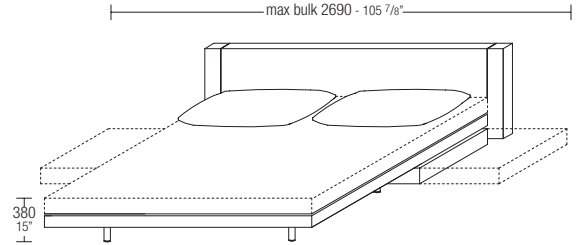

sofa-bed

sofa version W 2030 D 1150 H 670/900 W 79 7/8" D 45 1/4" H 26 3/8"/35 3/8"
bed version W 2030 D 2060 H 670 W 79 7/8" D 81 1/8" H 26 3/8"
mattress W 1800 D 2000 H 110 W 70 7/8" D 78 3/4" H 4 3/8"

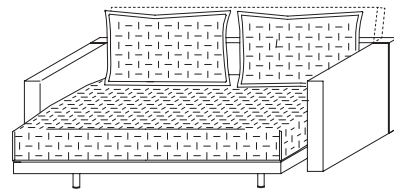

OD L200

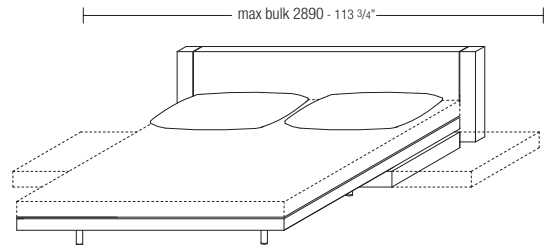

additional cushions
1 quilted side

single cushion
W 800 H 800
W 31 1/2" H 31 1/2"

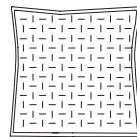

OCU80/80

single cushion
W 650 H 650
W 25 5/8" H 25 5/8"

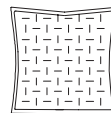

OCU60/60

single cushion (pillow)
W 800 H 550
W 31 1/2" H 21 5/8"

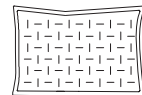

OCU70/40